

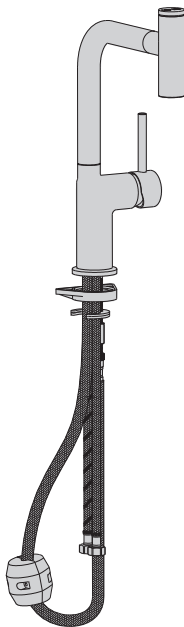

MOLLY



EAN CODE : 3276000592204
3276000596516
3276000632467

FR Manuel d'Instructions

ES Manual de Instrucciones

PT Manual de Instruções

IT Manuale di Istruzioni

EL Εγχειρίδιο Οδηγιών

PL Instrukcja Obsługi

RU Руководства по
Эксплуатации

KZ Пайдаланушы Нұсқаулығы

UA Інструкція з Експлуатації

RO Manual de Instrucțiuni

BR Manual de Instruções

EN Instructions Manual

2018/10-/V02

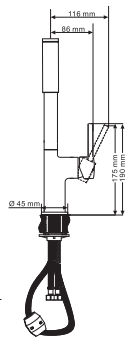
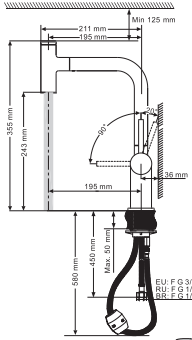



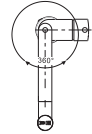
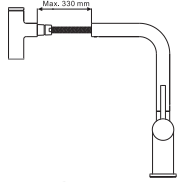

EU: F.G. 3/8" - 12/17
RU: F.G. 1/2" - 15/21
GR: F.G. 1/2" - 15/21

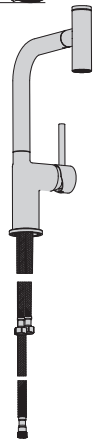

A



-  **B**
-  **C**
-  **D**
-  **E**
-  **F**
-  **G**
-  **H**





FR: Préparation / ES: Preparación / PT: Preparação / IT: Preparazione / EL: Προετοιμασία /
 PL: Przygotowanie / RU: Подготовка / KZ: Дайындау / UA: Підготовка / RO: Pregătire / BR: Preparação /
 EN: Preparation



FR: Montage / ES: Montaje / PT: Montagem / IT: Montaggio / EL: Συναρμολόγηση /
 PL: Montaż / RU: Сборка / KZ: Монтаждау / UA: Збірка / RO: Montaj / BR: Montagem /
 EN: Assembly



FR: Utilisation eau chaude-eau froide/ ES: Utilización agua caliente-agua fría/ PT: Utilização água quente-água fria/
 IT: Uso acqua calda-acqua fredda/ EL: Χρήση ζεστού-κρύου νερού/ PL: Użytkowanie zimnej wody-gorącej wody/
 RU: Використання гарячої води/ UA: води - холодної води/ RO: Utilizare apă caldă-apă rece/
 EN: Using hot and cold water



FR: Changement de cartouche/ ES: Cambio de cartucho/ IT: Cambio cartuccia/ PT: Mudança de cartucho/
 EL: Αλλαγή φυσιγγίου/ PL: Wymiana wkładu / RU: Смена картриджа/ KZ: Картриджі аустыруу/
 UA: Заміна картриджа/ RO: Schimbare cartus/ BR: Substituição de cartucho/ EN: Replacing the cartridge



FR: Changement de mousseur/ ES: Cambio de aireador/ PT: Mudança de arejador/ IT: Cambio rompigetto/
 EL: Αλλαγή αεράτορα / PL: Wymiana perlatora / RU: Смена аэратора/ KZ: Ауақаныңтыңғышты ауыстыру/
 UA: Заміна аератора/ RO: Schimbare aerator/ BR: Substituição do aerador/ EN: Replacing the aerator



FR: Changement de flexibles/ ES: Cambio de flexibles / PT: Mudança de flexíveis/ IT: Cambio flessibili/
 EL: Αλλαγή λάστιχων/ PL: Wymiana wężyków instalacyjnych / RU: Смена гибкого шланга для смесителя/
 UA: Заміна гнучкого шланга для змішувача/ KZ: Қоспалауышқа арналған иілгіш шлангты ауыстыру/
 RO: Schimbare furtune flexibile/ BR: Substituição das mangueiras/ EN: Replacing the hoses

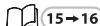



FR: Préparation / ES: Preparación / PT: Preparação / IT: Preparazione / EL: Προετοιμασία /
PL: Przygotowanie / RU: Подготовка / KZ: Дайындау / UA: Підготування / RO: Pregătire /
BR: Preparação / EN: Preparation

1

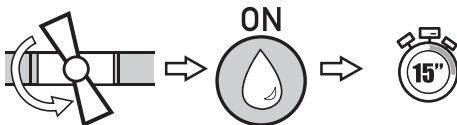

2

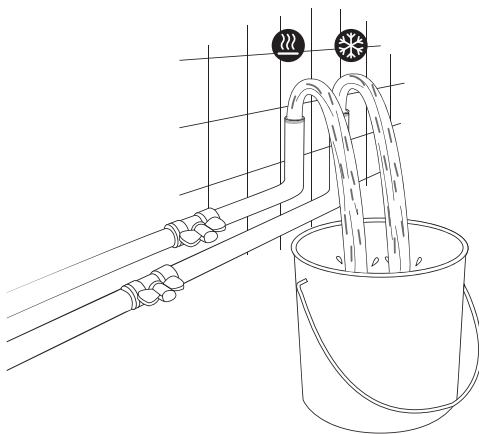

3

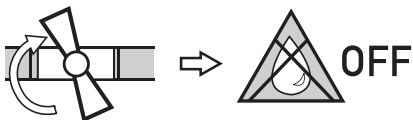



FR: Montage / ES: Montaje / PT: Montagem / IT: Montaggio / EL: Συναρμολόγηση /
PL: Montaż / RU: Сборка / KZ: Монтаж / UA: Збірка / RO: Montaj / BR: Montagem /
EN: Assembly

1

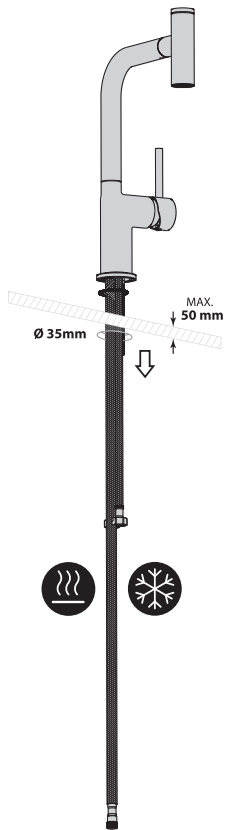



C



D



E



F



2



14mm

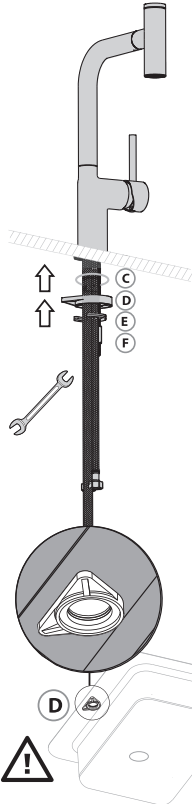

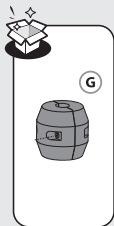

2

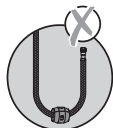
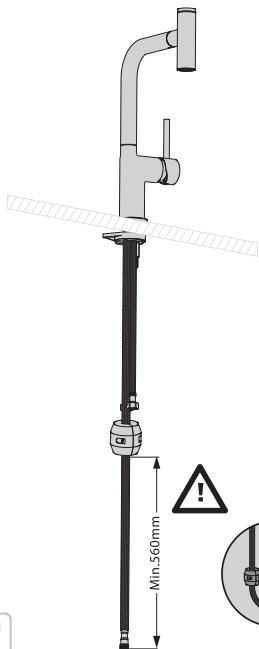
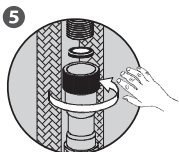
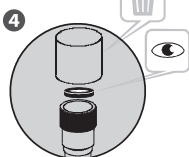
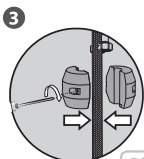
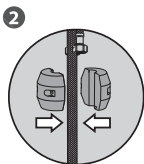
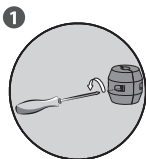
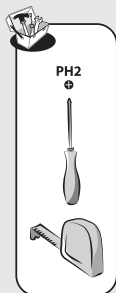

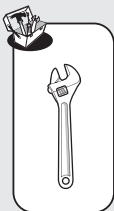

3

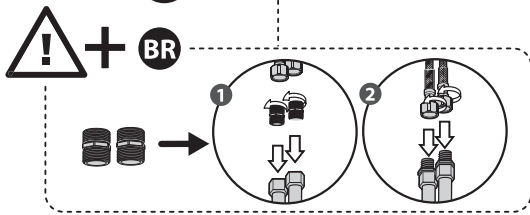
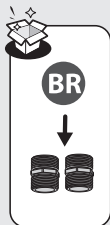
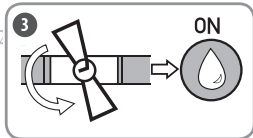
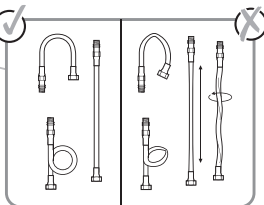
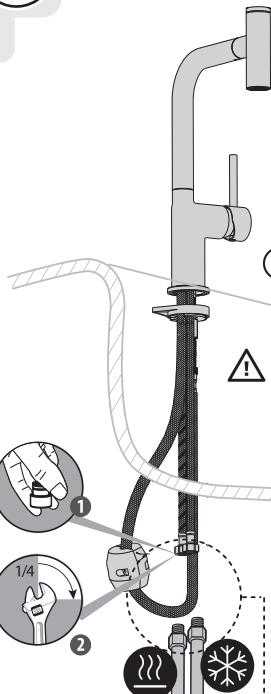



FR: Utilisation eau chaude-eau froide/ ES: Utilización agua caliente-agua fría/ PT: Utilização água quente-água fria/
IT: Uso acqua calda-acqua fredda/ EL: Χρήση ζεστού-κρύου νερού/ PL: Użytkowanie zimnej-wodę-gorącej wody/
RU: Використання гарячої води/ KZ: Суық және ыстық суды қолдану/ UA: води - холодної води/
RO: Utilizare apă caldă-apă rece/ BR: Uso de água quente e fria/ EN: Using hot and cold water

1

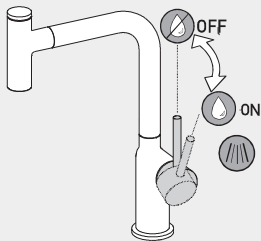
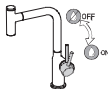

2

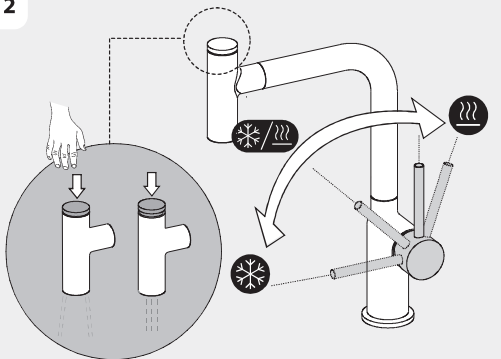

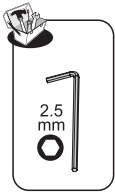

FR: Changement de cartouche/ ES: Cambio de cartucho/ IT: Cambio cartuccia/ PT: Mudança de cartucho/
EL: Αλλαγή φουσιγγίου/ PL: Wymiana wkładu / RU: Смена картриджа/ KZ: Картриджи ауыстыруу/
UA: Заміна картриджа/ RO: Schimbare cartus/ BR: Substituição de cartucho/ EN: Replacing the cartridge

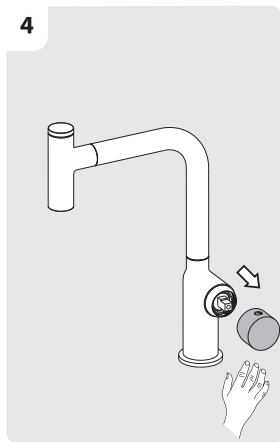
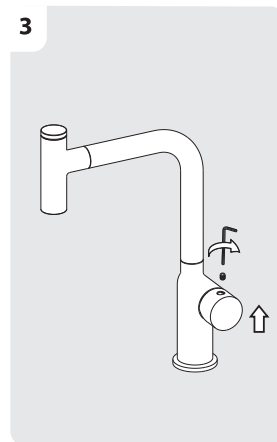
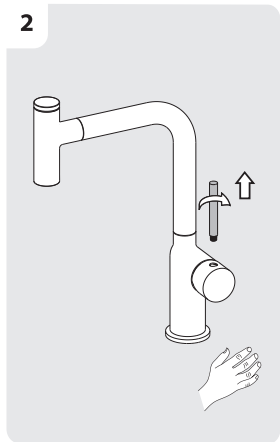
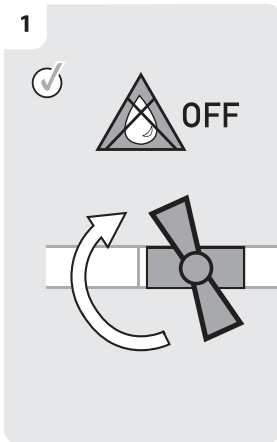

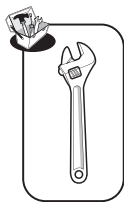

FR: Changement de cartouche/ ES: Cambio de cartucho/ IT: Cambio cartuccia/ PT: Mudança de cartucho/
EL: Αλλαγή φιοτιγγίου/ PL: Wymiana wkładu / RU: Смена картриджа/ KZ: Картриджи ауыстыру/
UA: Заміна картриджа/ RO: Schimbare cartus/ BR: Substituição de cartucho/ EN: Replacing the cartridge

5

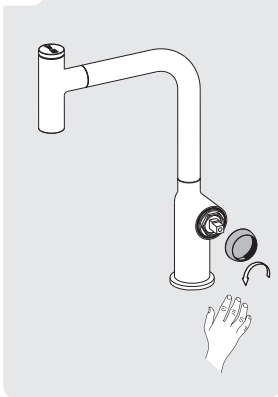

6

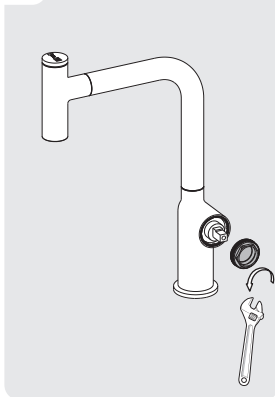

7



8

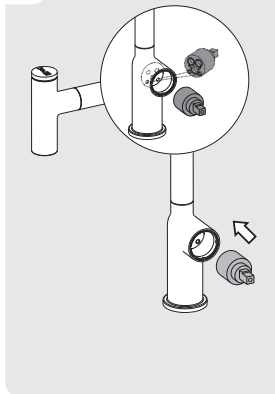

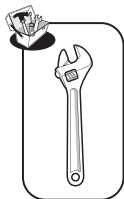

FR: Changement de cartouche/ ES: Cambio de cartucho/ IT: Cambio cartuccia/ PT: Mudança de cartucho/
EL: Αλλαγή φασίγγιου/ PL: Wymiana wkładu / RU: Смена картриджа/ KZ: Картриджи ауыстыру/
UA: Заміна картриджа/ RO: Schimbare cartuş/ BR: Substituição de cartucho/ EN: Replacing the cartridge

9

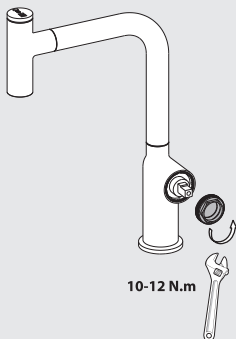

10

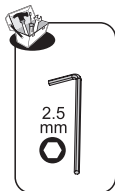
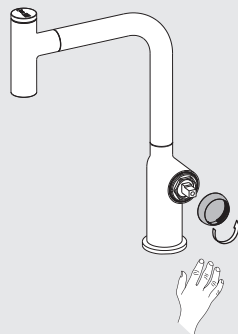

11

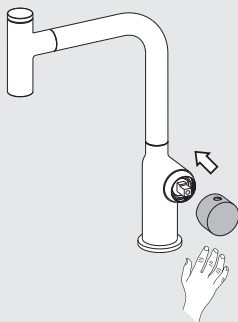

12

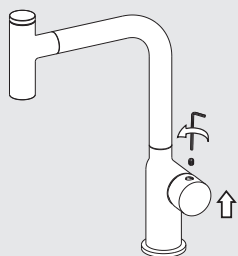



FR: Changement de cartouche/ ES: Cambio de cartucho/ IT: Cambio cartuccia/ PT: Mudança de cartucho/
EL: Αλλαγή φιογγίου/ PL: Wymiana wkładu / RU: Смена картриджа/ KZ: Картриджді ауыстыру/
UA: Заміна картриджа/ RO: Schimbare cartus/ BR: Substituição de cartucho/ EN: Replacing the cartridge

1

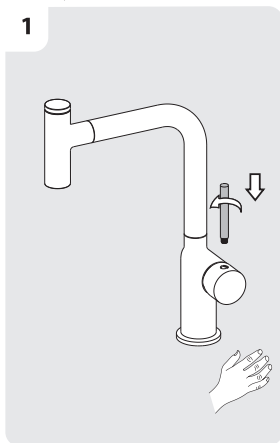

2

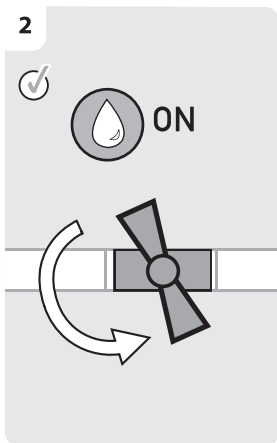

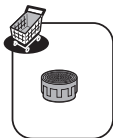

FR: Changement de mousseur/ ES: Cambio de aireador/ PT: Mudança de arejador/ IT: Cambio rompigetto/
 EL: Αλλάξη αεράτορα / PL: Wymiana perlatora / RU: Смена аэратора/ KZ: Ауақанықтырғышты ауыстыру/
 UA: Заміна аератора/ RO: Schimbare aerator/ BR: Substituição do aerador/ EN: Replacing the aerator

1

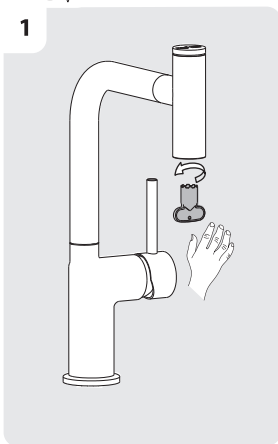

2

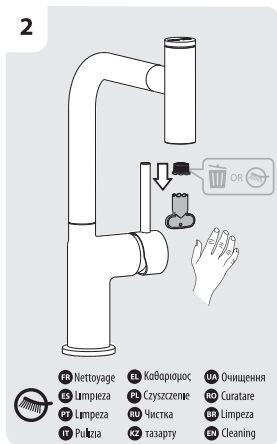

- | | | |
|--------------|----------------|-------------|
| FR Nettoyage | EL Καθαρισμός | UA Очищення |
| ES Limpieza | PL Czyszczenie | RO Curățare |
| PT Limpeza | RU Чистка | BR Limpeza |
| IT Pulizia | KZ тазарту | EN Cleaning |

3

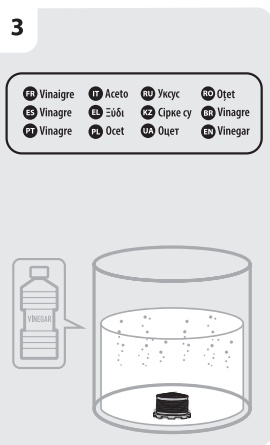

- | | | | |
|-------------|----------|-------------|------------|
| FR Vinaigre | IT Aceto | RU Уксус | RO Oțet |
| ES Vinagre | EL Ξίδι | KZ Сірке су | BR Vinagre |
| PT Vinagre | PL Ocet | UA Оцет | EN Vinegar |

4

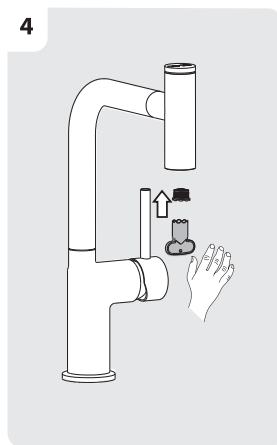



FR: Changement de flexibles/ ES: Cambio de flexibles / PT: Mudança de flexíveis/ IT: Cambio flessibili/
EL: Αλλαγή λάστιχων/ PL: Wymiana wężyków instalacyjnych / RU: Смена гибкого шланга для смесителя/
UA: Заміна гнучкого шланга для змішувача/ KZ: Қоспалауышқа арналған иілгіш шлангты ауыстыру/
RO: Schimbare furtune flexibile/ BR: Substituição das mangueiras/ EN: Replacing the hoses

1

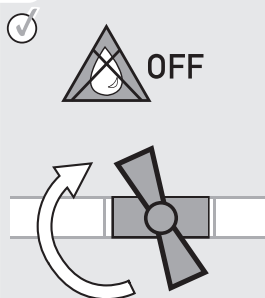

2

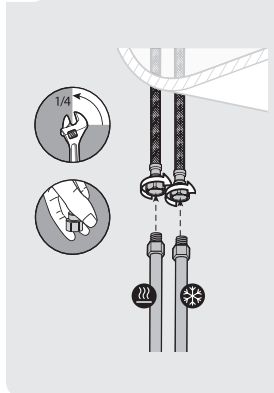

3

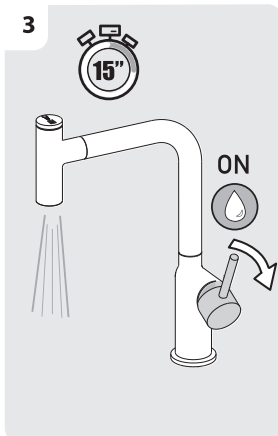

4

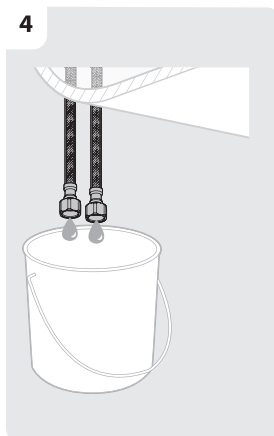



FR: Changement de flexibles/ ES: Cambio de flexibles / PT: Mudança de flexíveis/ IT: Cambio flessibili/
 EL: Αλλαγή λάστιχων/ PL: Wymiana wężyków instalacyjnych / RU: Смена гибкого шланга для смесителя/
 UA: Заміна гнучкого шланга для змішувача/ KZ: Қоспауышқа арналған иілгіш шлангты ауыстыру/
 RO: Schimbare furtune flexibile/ BR: Substituição das mangueiras/ EN: Replacing the hoses

5

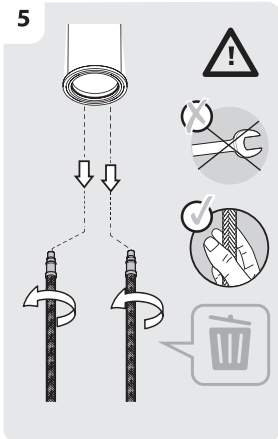

6

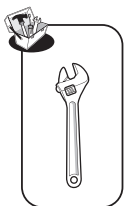
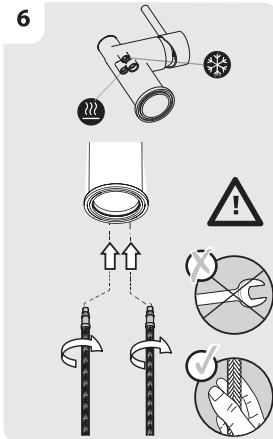

7

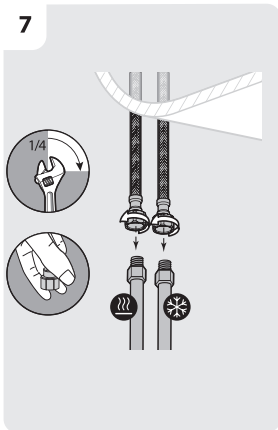

8

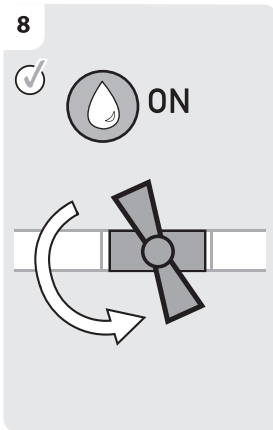



Eau claire / Agua limpia / Água limpa / Acqua pulita / Καθαρό νερό / Czysta woda / Чистая вода / Água limpa /
Чиста вода / Apa curata / таза су / Clean water



Sans solvant / Sin disolvente / Sem solventes / Senza solventi / Χωρίς διαλυτικά / Bez rozpuszczalnika / Без растворителя /
Sem solventes/ Без розчинника / Fara solvent / еріткішсіз/ Solvent-free

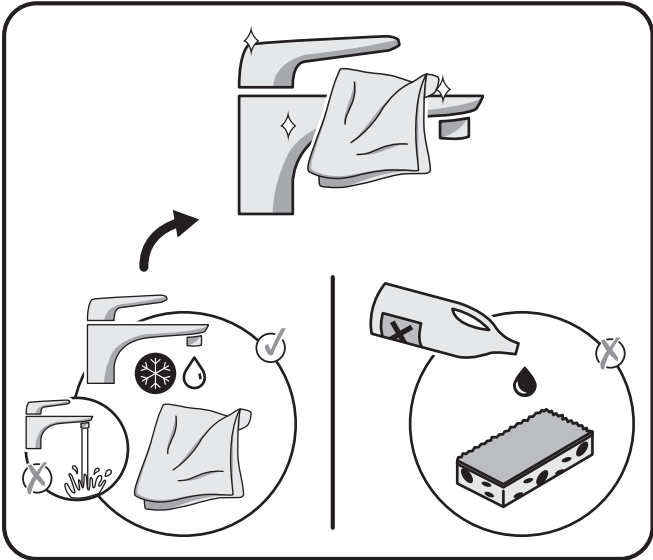

NO	DESCRIPTION	CODE NO	QTY	REMARK
1	Handle	42003.001CR	1	
2	Beautify Cover	603024 CR	1	
3	Pressing Nut	604121 BC	1	
4	Cartridge	59-33 COLD S/D MIRROR	1	
5	Mixer Body	41008.001CR	1	
6	Shower hose	PULL OUT TWIST H11X1-H1/2 CONET-1500	1	
7	Spout	401159 CR	1	
8	Check valve	304043.000	1	
9	Hand shower	K11101CP	1	
10	Neoperl	442300.010	1	
11	Key	099150.000	1	
12	O ring	132	1	
13	Triangle base	47003.001BC	1	
14	Fixing pack	47005.001BC	1	
15	Weight	92647BC	1	
16	Inlet hose	TAC-PEX-DN6-ACB H3/8-M8X1 L12-550	2	3276000592204
17	Connector	TAC-PEX-DN6-ACB H1/2-488X1 L12-550	2	3276000632467/3276000596516

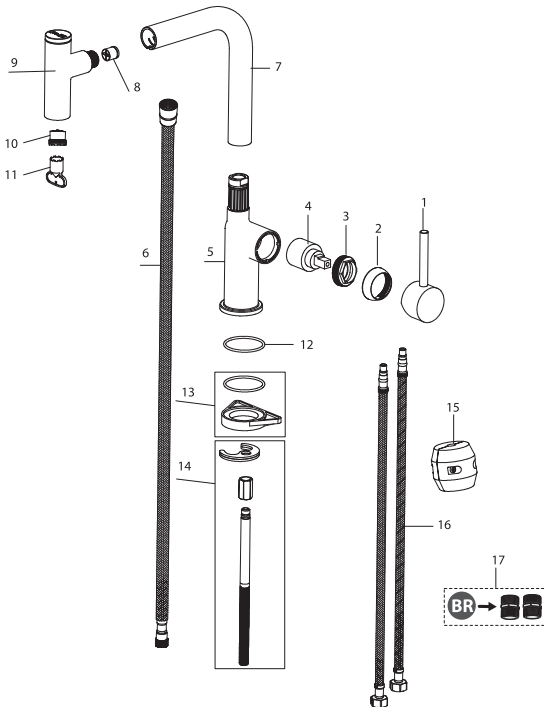

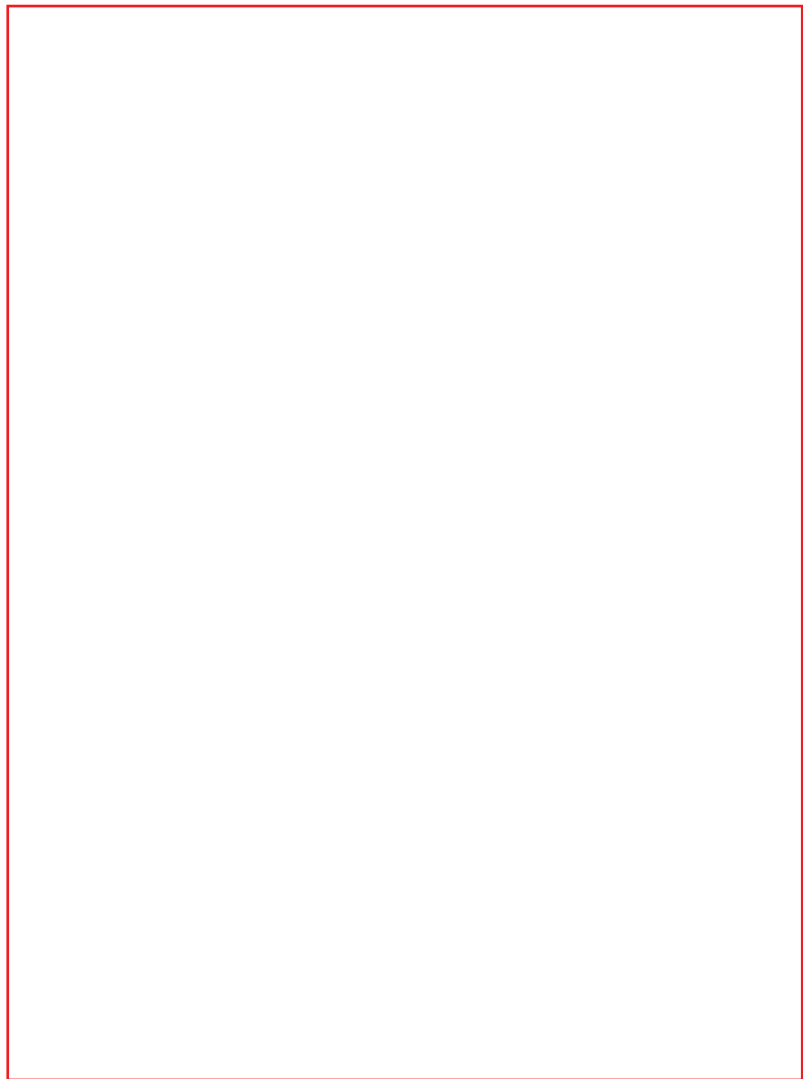

- FR** : La présence sur ce robinet d'un ou plusieurs clapet(s) anti-retour est nécessaire au bon fonctionnement de l'ensemble de votre installation en eau. Ne tentez pas de le(s) retirer.
- ES** : La presencia en este grifo de una o de varias válvula(s) de retención es necesaria para el buen funcionamiento del conjunto de su instalación de agua. No intente retirarla(s).
- PT** : A presença nesta torneira de uma ou mais válvula(s) de retenção é necessária para o funcionamento adequado de toda a instalação de água. Não tente removê-la(s).
- IT** : La presenza su questo rubinetto di una o più valvole anti riflusso è necessaria per il buon funzionamento della totalità del vostro impianto in acqua. Non tentare di rimuoverle.
- PL** : Obecność jednego lub więcej zaworów zwrotnych kranu jest niezbędna dla prawidłowego funkcjonowania całej instalacji wodnej. Nie należy ich usuwać.
- EL** : Η παρουσία σε αυτήν την μπλεταρία, μίας ή περισσοτέρων, βαλβίδων αντεπιστροφής είναι απαραίτητη για την καλή λειτουργία του συνόλου της υδραυλικής σας εγκατάστασης. Μην επιχειρήσετε να τις αποσπάσετε.
- RU** : Наличие на этом кране одного или нескольких обратных клапанов необходимо для для правильной работы всей водопроводной установки. Не пытайтесь его/их снимать.
- KZ** : Бұл шумектегі бір немесе бірнеше қайырмалы қақпақашының болуы түгел су құбыры қондырғысының дұрыс жұмыс жасауы үшін қажет. Оны/оларды алып тастауға тырыспаңыз.
- UA** : Наявність на цьому крані одного або декількох зворотних клапанів необхідна для правильної роботи всієї водопровідної установки. Не намагайтеся його/їх знімати.
- RO** : Prezența pe această robinet a unei sau mai multor supape de reținere este necesară pentru buna funcționare a întregii dvs. instalații de apă. Nu încercați să le eliminați.
- BR** : A presença de uma ou mais válvula(s) anti-retorno nessa torneira é necessária para o funcionamento adequado da sua instalação de água. Não tente remover a(s) válvula(s).
- EN** : The presence of one or more anti-return valve(s) on this tap is required for proper operation of your water setup. Please do not attempt to remove it/them.



Certificado de conformidad sanitaria.
 Atestado de conformidade sanitária.
 certificado di conformità sanitaria.
 Βεβαίωση υγειονομικής συμμόρφωσης.
 Certyfikat zgodności sanitarnej.
 Декларация о соответствии санитарным нормам
 Санитарлық талаптарға сәйкестік декларациясы
 Декларация про відповідність санітарним нормам
 Atestat de conformitate sanitară
 Certificado de conformidade sanitária.
 Declaration of sanitary conformity.
 Attestation de conformité sanitaire



* Garantie 10 ans / 10 años de garantía / Garantia de 10 anos / Garanzia 10 Anni / Εγγύηση 10 ετών / Gwarancja 10-letnia / Гарантия 10 года / Кепілдік 10 жыл / Гарантія 10 років / Garanție 10 ani / 10 años de garantía / 10-year guarantee

Made in P.R.C 2018

ADEO Services - 135 Rue Sadi Carnot - CS 00001
 59790 RONCHIN - France

UA ТОВ «Леруа Мерлен Україна»,
 вул. Полларна 17а, м. Київ 04201, Україна

