

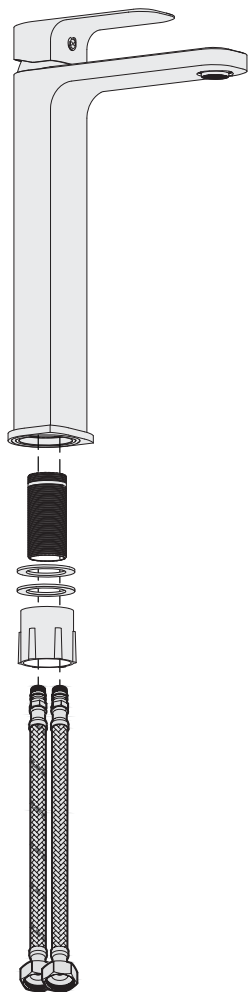

REMIX



- FR** Notice de Montage, Utilisation, Entretien
- ES** Instrucciones de Montaje, Utilización y Mantenimiento
- PT** Instruções de Montagem, Utilização e Manutenção
- IT** Istruzioni per il Montaggio, l'Uso e la Manutenzione
- EL** Εγχειρίδιο συναρμολόγησης, χρήσης και συντήρησης
- PL** Instrukcja Montażu, Użytkowania i Konserwacji
- RU** Руководство По Сборке и Эксплуатации
- UK** Керівництво По Збірці і Експлуатації
- RO** Manual asamblare, utilizare și întreținere
- EN** Assembly - Use - Maintenance Manual

3276000251644
3276000251507
3276000251293



2016-10

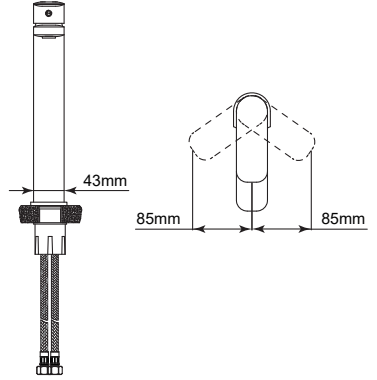
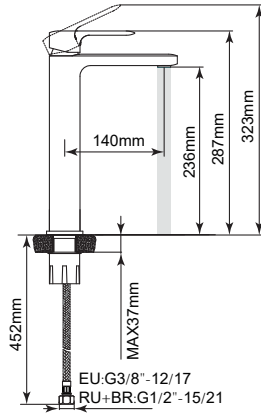
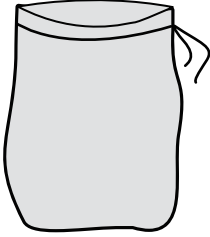
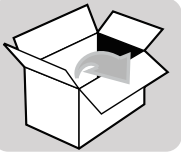

B



D



E



F



G

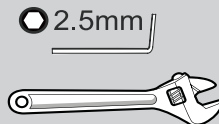
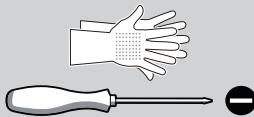
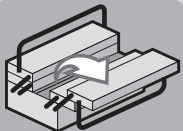
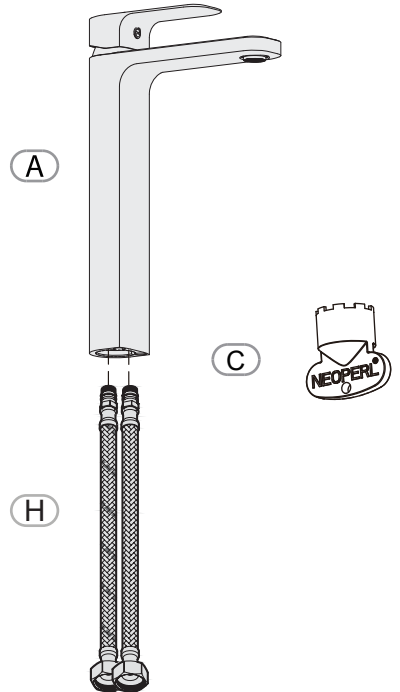



Observez / Atención / Aviso / Osservare / Προσέξτε / Przestrzegaj / Соблюдайте правила техники безопасности /
Дотримуйтеся правил техніки безпеки / Respectați / Observe



Nettoyage / Limpieza / Limpeza / Pulizia / Καθαρισμός / Czyszczenie / Чистка / Очищення / Curățare / Cleaning



Eau claire / Agua limpia / Água limpa / Acqua pulita / Καθαρό νερό / Czysta woda / Чистая вода / Чиста вода /
Apă curată / Clean water



Sans solvant / Sin disolvente / Sem solventes / Senza solventi / Χωρίς διαλυτικά / Bez rozpuszczalnika / Без растворителя /
Без розчинника / Fără solvent / Solvent-free



Attendre / Espera / Esperar / Attendere / Αναμονή / Zaczekać / Режим ожидания / Режим очікування /
Așteptare / Wait



Maintenance / Mantenimiento / Manutenção / Manutenzione / Σέρβις / Utrzymanie / Техническое обслуживание /
Технічне обслуговування / Mentenanță / Maintenance

Notes / Observaciones / Notas / Note / Σημειώσεις / Notatki / Примечания / Примітки / Note / Notes

1

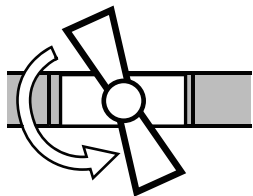

2

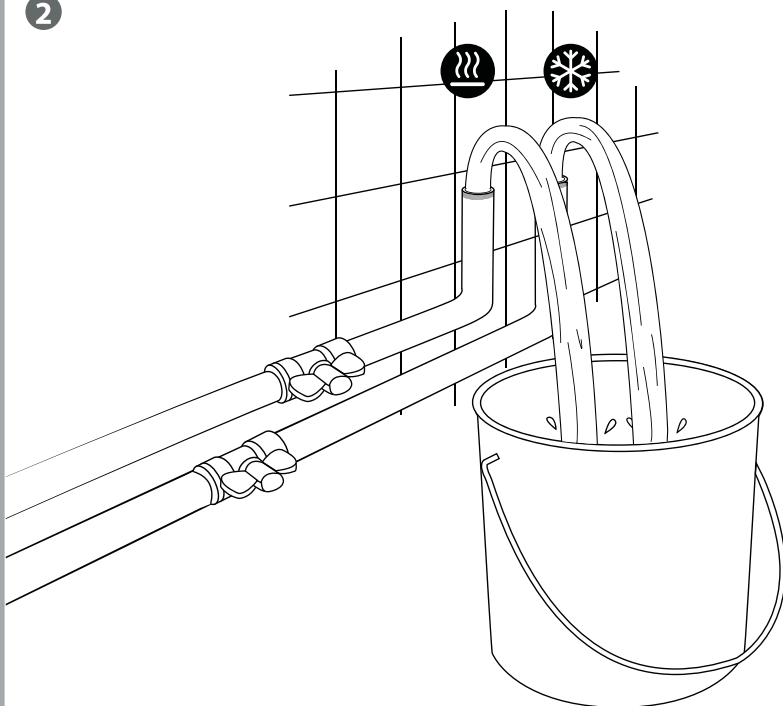

3

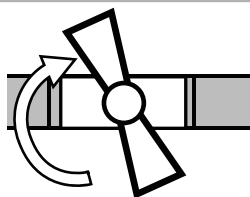

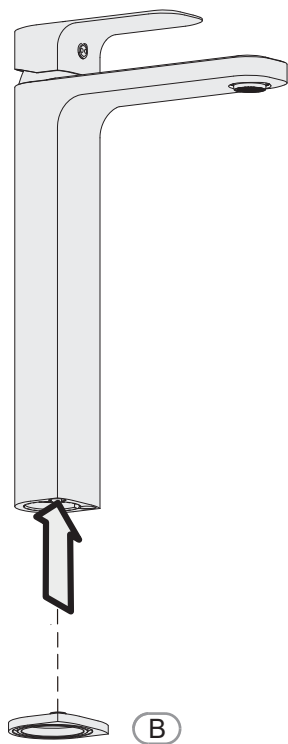

B

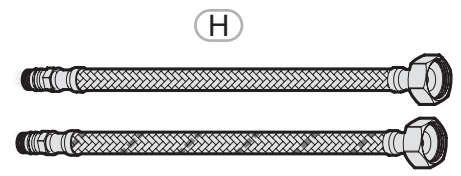
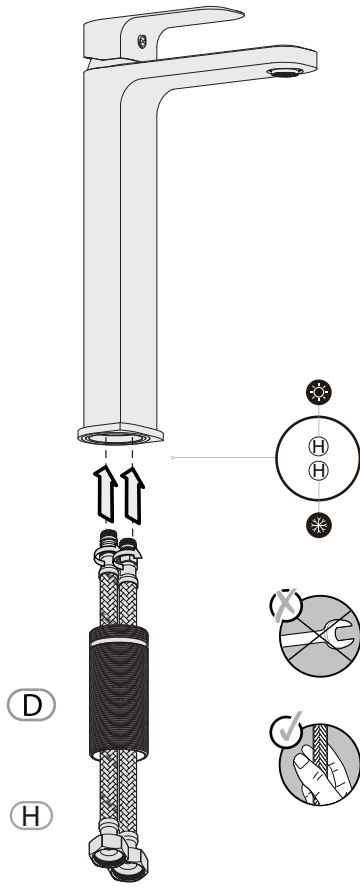

4a

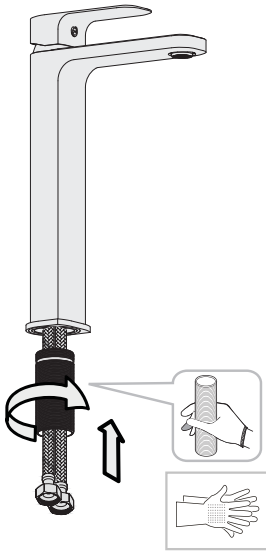

4b

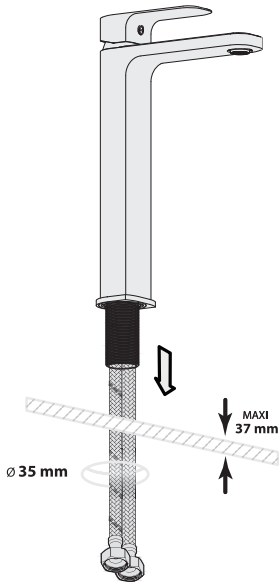

5

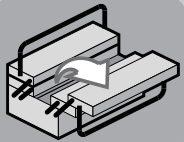
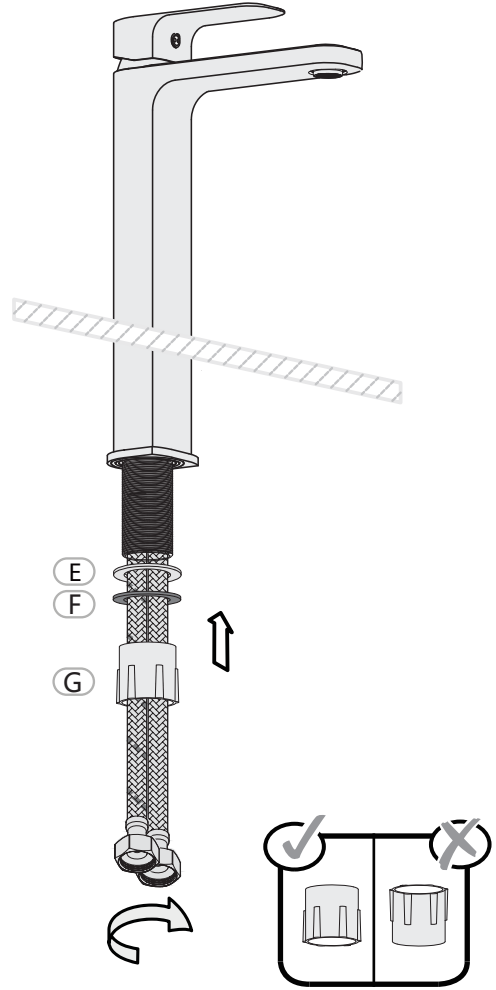

E



F



G

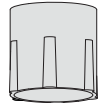

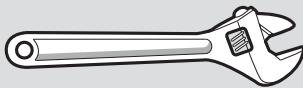
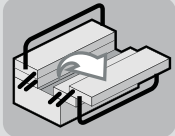
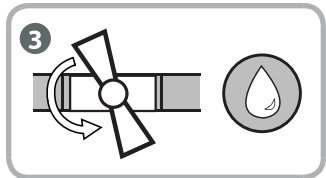
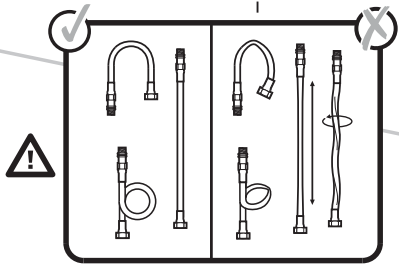
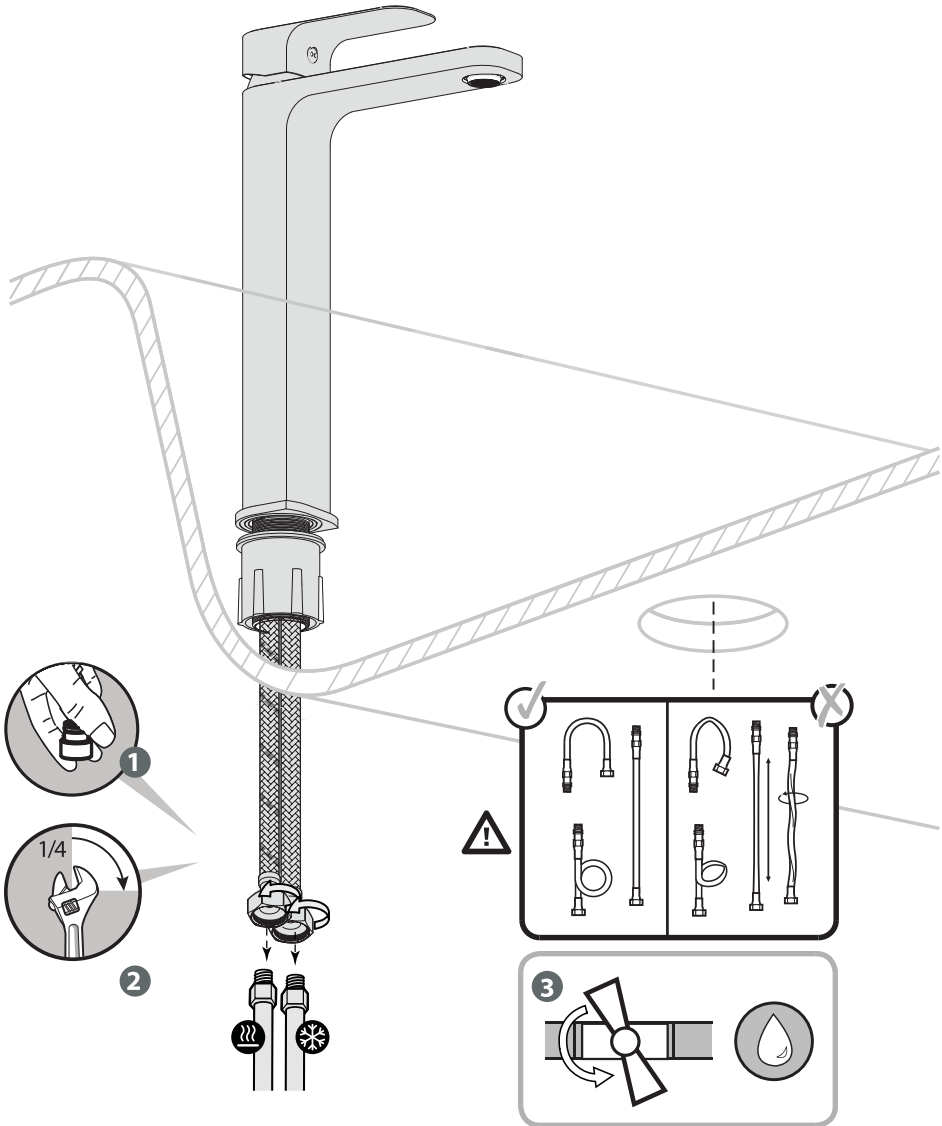

Utilisation eau chaude-eau froide / Utilización agua caliente-agua fría / Utilização água quente-água fria / Uso acqua calda-acqua fredda / Χρήση ζεστού-κρύου νερού / Użytkowanie zimnej wody-gorącej wody / Использование горячей воды - холодной воды / Використання гарячої / води - холодної води / Utilizare apă caldă-apă rece / Using hot and cold water

A

1

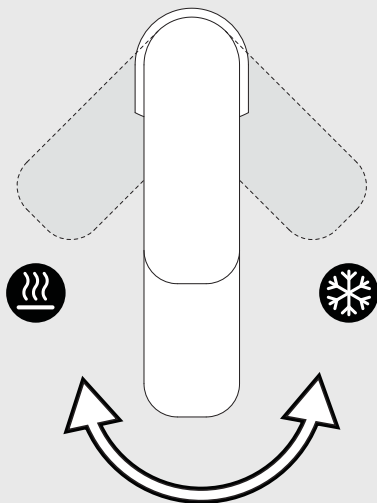
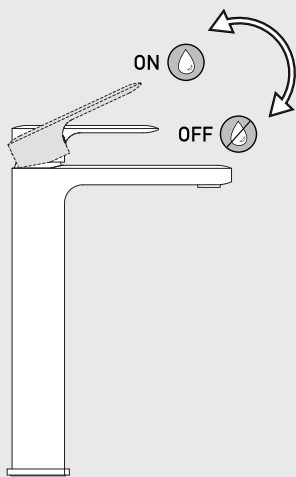

B

Changement de cartouche / Cambio de cartucho / Mudança de cartucho / Cambio cartuccia
Αλλαγή φουσιγγίου / Wymiana wkładu / Смена картриджа / Заміна картриджа / Schimbare
cartuş / Replacing the cartridge

1



OFF

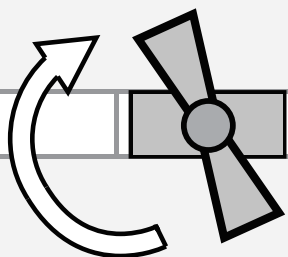

2

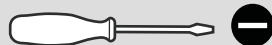
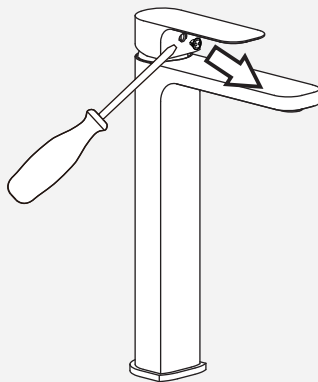

3

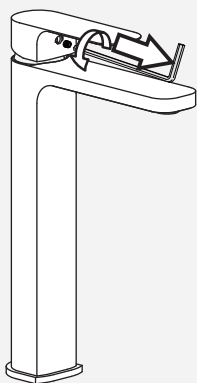

○ 2.5mm



4

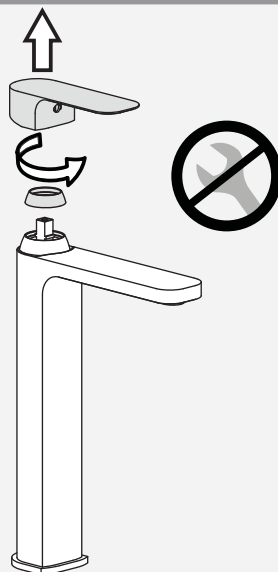

5

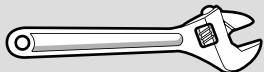
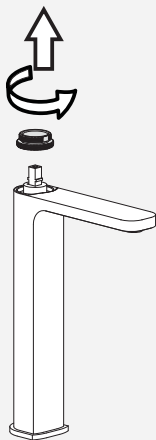

6

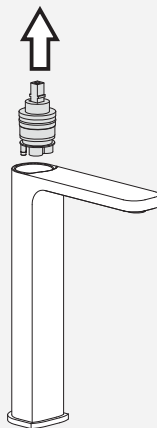

7

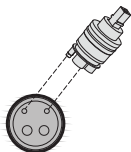
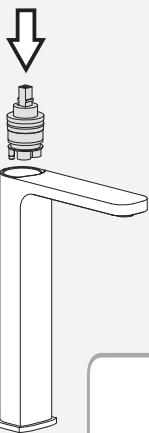

8

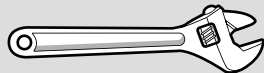
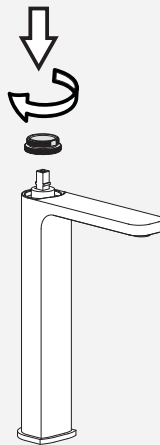

B

Changement de cartouche / Cambio de cartucho / Mudança de cartucho / Cambio cartuccia
Αλλαγή φυσιγγίου / Wymiana wkładu / Смена картриджа / Заміна картриджа / Schimbare
cartuș / Replacing the cartridge

9

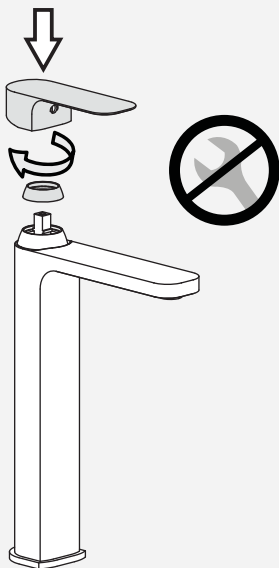

10

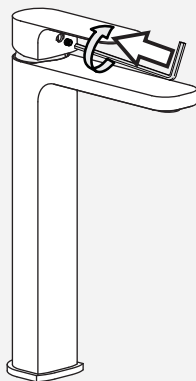

○ 2.5mm

11

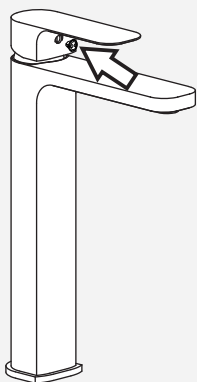

12



ON

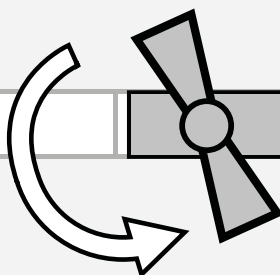

Changement de mousseur / Cambio de aireador / Mudança de arejador / Cambio rom-pigetto / Αλλαγή αεράτορα / Wymiana perlatora / Смена аэраτορα / Заміна аератора / Schimbare aerator / Replacing the aerator

C

1

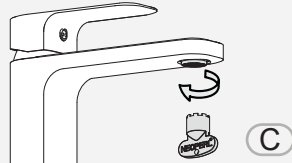

2

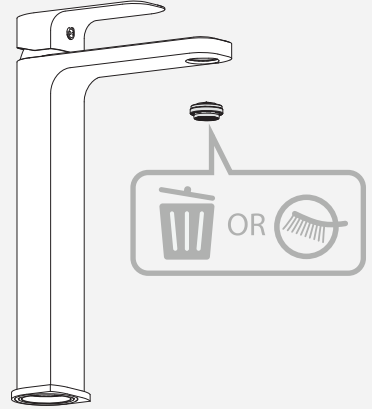

3

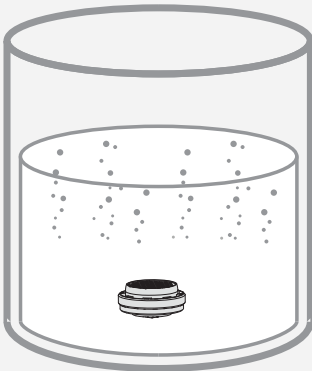

4

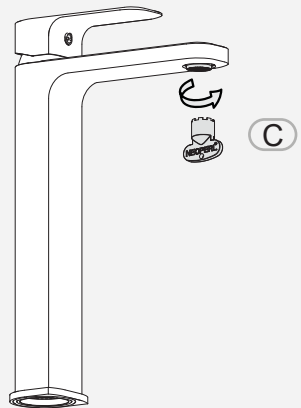

D

Changement de flexibles / Cambio de flexibles / Mudança de flexíveis / Cambio flessibili / Αλλαγή λάστιχων / Wymiana wężyków instalacyjnych / Смена гибкого шланга для смесителя / Заміна гнучкого шланга для змішувача / Schimbare furtune flexibile / Replacing the hoses

1

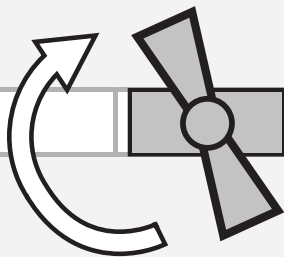
**OFF**

2

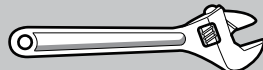
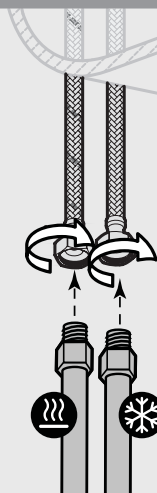
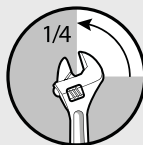

3

15"

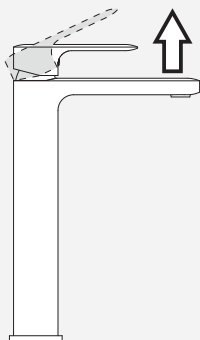

4

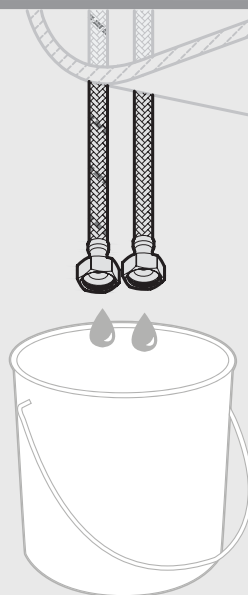

Changement de flexibles / Cambio de flexibles / Mudança de flexíveis / Cambio flessibili / Αλλαγή λάστιχων / Wymiana wężyków instalacyjnych / Смена гибкого шланга для смесителя / Заміна гнучкого шланга для змішувача / Schimbare furtune flexibile / Replacing the hoses

D

5

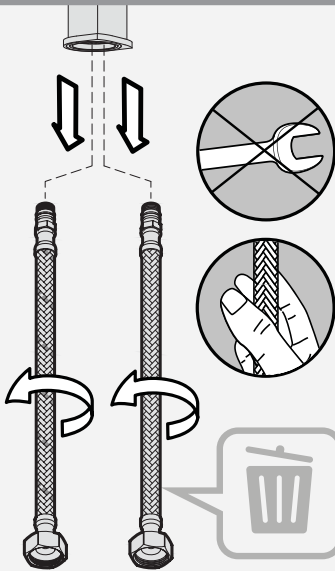

6

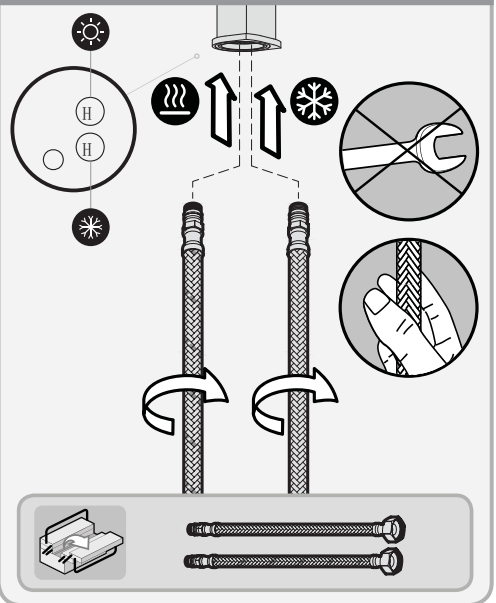

7

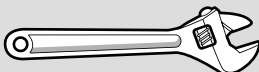
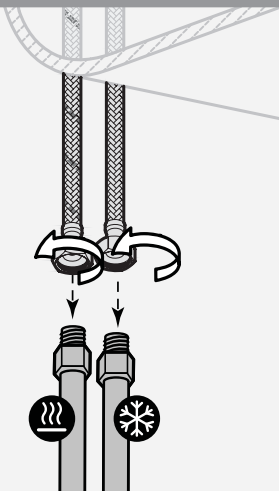

8



ON

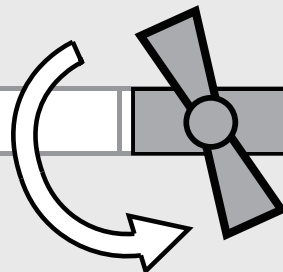

ADEO Services
135 Rue Sadi Carnot
CS 00001
59790 RONCHIN - France

ТОВ «Леруа Мерлен Україна»,
вул. Полярна 17а, м. Київ
04201, Україна

ООО ЛЕРУА МЕРЛЕН ВОСТОК,
141031, Московская область,
Мытищинский район, г. Мытищи,
Осташковское шоссе, д.1, РОССИЯ

* Garantie 5 ans / Garantía 5 años / Garantia 5 anos / Garanzia 5 anni
Εγγύηση 5 ετών / Gwarancja 5 lat / 5 летняя / 5-річна гарантія
5 ani garanție / Guarantee 5 years

Made In P. R.C. 2016