



Гарантия
5
лет*

ROMA



M10X1

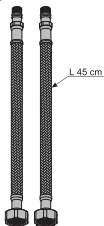

EAN CODE: 3276007035353
3276007035384

RU Руководство по
BY Эксплуатации

KZ Пайдалану жөніндегі
басшылық

EN Instructions Manual

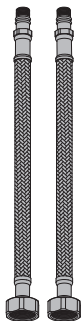
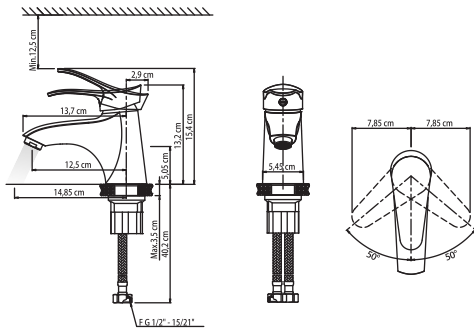

C

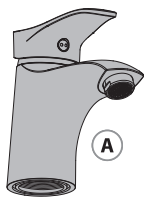

A



B



D



E



F



MIN. 35 mm





RU/BY: Подготовка / **KZ:** Дайындау / **EN:** Preparation



4



RU/BY: Сборка / **KZ:** Құрастыру / **EN:** Assembly



5 → 7



RU/BY: Использование горячей и холодной воды/
KZ: Суық және ыстық суды қолдану / **EN:** Using hot and cold water



8

RU/BY: Смена картриджа / **KZ:** Картриджді ауыстыру / **EN:** Replacing the cartridge



9 → 12

RU/BY: Смена аэратора / **KZ:** Аэратор ауыстыру / **EN:** Replacing the aerator



13

RU/BY: Смена гибкого шланга для смесителя /

KZ: Қоспалауышқа арналған иілгіш шлангты ауыстыру / **EN:** Replacing the hoses



14 → 15



RU/УУ: Подготовка / KZ: Дайындау / EN: Preparation

1

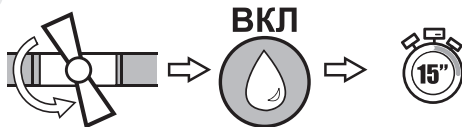

2

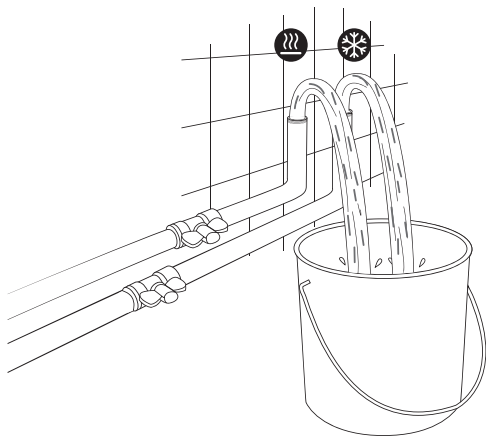

3

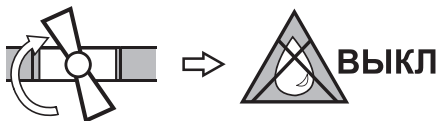

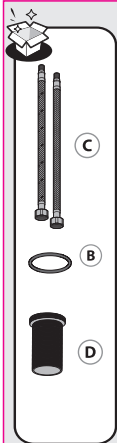

1

1



D



3

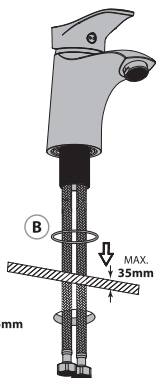

2

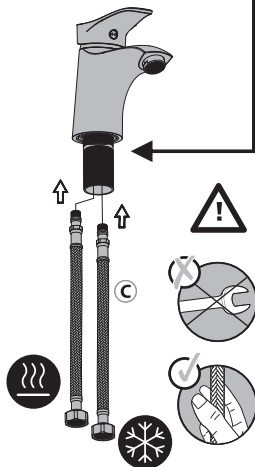
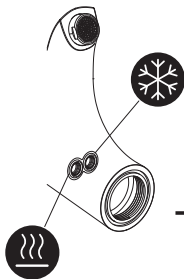

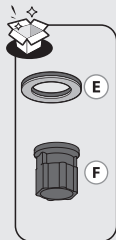

2

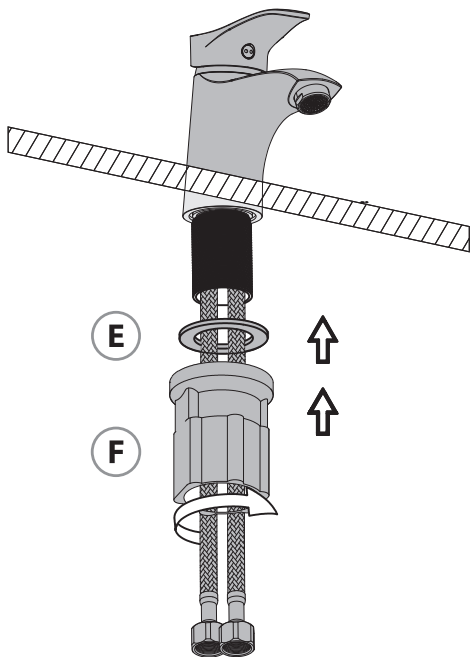



MIN. 35 mm



3

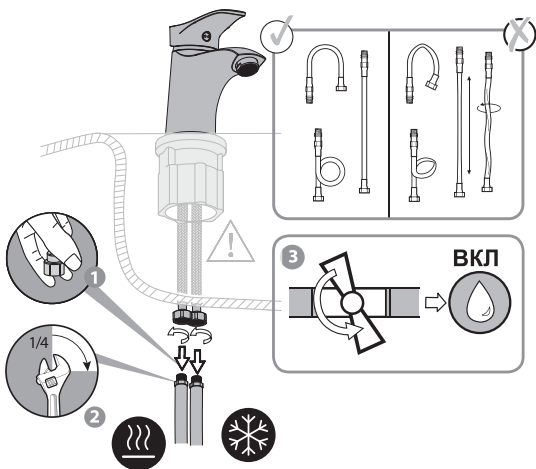



RU/ВУ: Использование горячей и холодной воды/
KZ: Суық және ыстық суды қолдану/ EN: Using hot and cold water

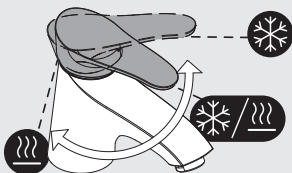
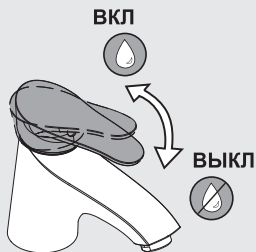

No./Номер/Нөмір	Description/Описание/Сипаттама	Code No./Номер кода/Код нөмірі	QTY/Кол-во/Мөлшері
1	Handle/Ручка/Тутқа	H745	1
2	Cartridge/Картридж/Картридж	40D-2	1
3	Fixing part/Крепеж/Бекіту бөлігі	41038000300	1
4	Neoperl/Аэратор/Аэратор	40.0003.000	1
5	Inlet hose/Гибкий шланг/Кіріс шланг	21450300303	2

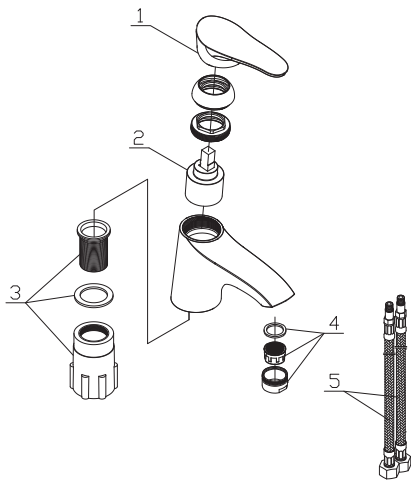

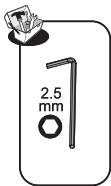

RU/BY: Смена картриджа / **KZ:** Картриджді ауыстыру /
EN: Replacing the cartridge

1



ВЫКЛ

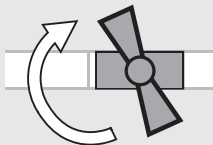

2

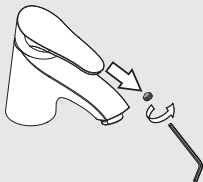

3

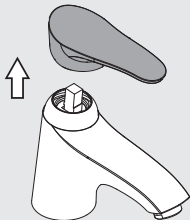

4



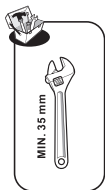

RU/ВУ: Смена картриджа/ KZ: Картриджді ауыстыру/
EN: Replacing the cartridge

5

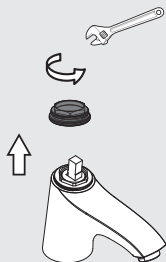

6

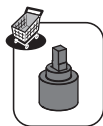

7

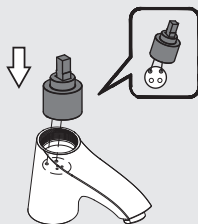

8





RU/BY: Смена картриджа/ **KZ:** Картриджді ауыстыру/
EN: Replacing the cartridge

9



10

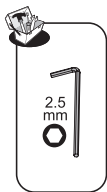
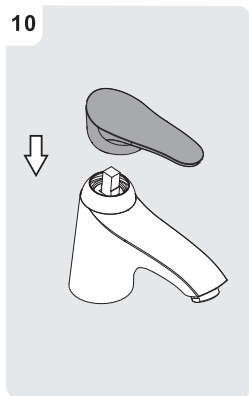

11



12



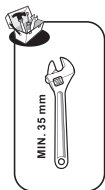

RU/BY: Смена аэратора/ **KZ:** Аэратор ауыстыру/ **EN:** Replacing the aerator

1

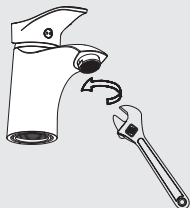

2

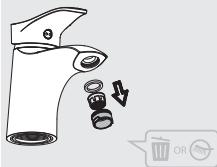

RU Чистка **KZ** тазарту **EN** Cleaning
BY

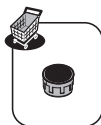

3

RU Уксус **KZ** Сірке су **EN** Vinegar
BY

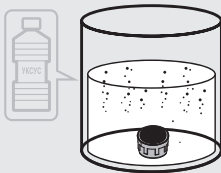

4

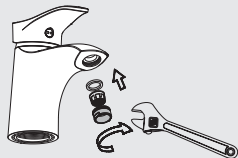



RU/ВУ: Смена гибкого шланга для смесителя/

KZ: Қоспалауышқа арналған иілгіш шлангты ауыстыру/ EN: Replacing the hoses

1



ВЫКЛ

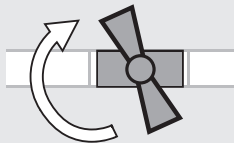

2

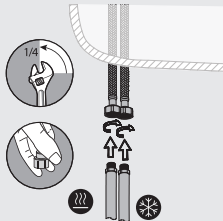

3

ВКЛ



4





RU/ВУ: Смена гибкого шланга для смесителя/

KZ: Қоспалауышқа арналған иілгіш шлангты ауыстыру/ EN: Replacing the hoses

5

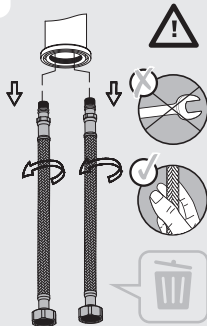

6

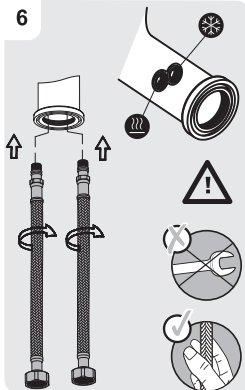

7

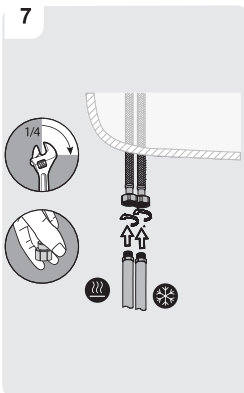

8

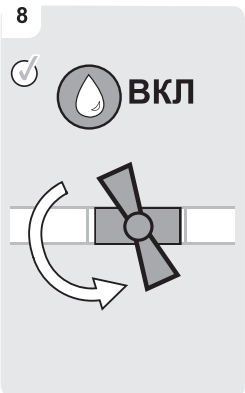



Чистая вода / Таза су / Clean water



Без розчинителя / Ериткішсіз / Solvent-free

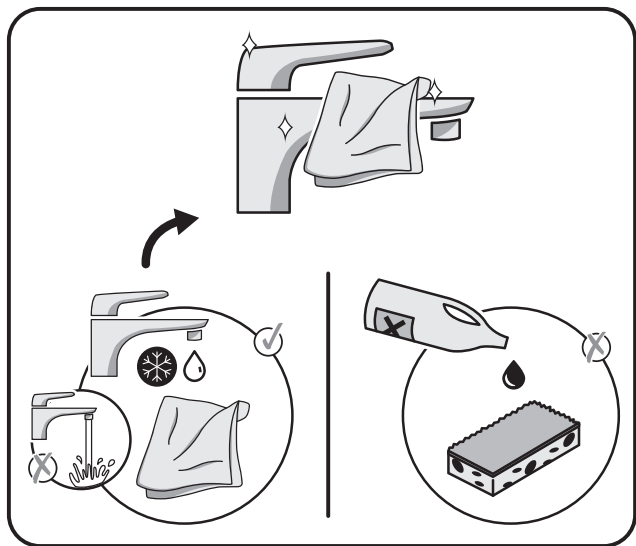



Декларация о соответствии санитарным нормам
Санитарлық талаптарға сәйкестік декларациясы
Declaration of sanitary conformity.

* Кепілдік 5 жыл / Гарантия 5 лет / 5 -year guarantee

Made in P.R.C. 2019

- FR** ADEO Services - 135 Rue Sadi Carnot - CS 00001
59790 RONCHIN - France
- UA** ТОВ «Леруа Мерлен Україна»,
вул. Полярна 17а, м. Київ 04201, Україна
- RU** ООО ЛЕРУА МЕРЛЕН ВОСТОК, 141031, Московская
область, г. Мытищи, Осташковское шоссе, д.1, РОССИЯ
- BY** ООО «Леруа Мерлен Бел», 220020, Республика Беларусь,
город Минск, проспект Победителей, 100, офис 503

KZ Қазақстан Республикасында өнім сапасы бойынша
наразылықтарды қабылдауға уәкілетті ұйым: «Леруа Мерлен
Қазақстан» ЖШС, Қазақстан Республикасы, 050000,
Алматы қ., Қонаев көшесі, 77, «PARKVIEW»-60, 6-қабат, 07-кеңсе.
Организация, уполномоченная принимать претензии по
качеству продукции в Республике Казахстан: ТОО «Леруа
Мерлен Казахстан», Республика Казахстан, 050000, г. Алматы,
ул. Қунаева, 77, БЦ «ParkView», 6 этаж, офис №07.

