

EAN CODE

3276007112276

3276007112283

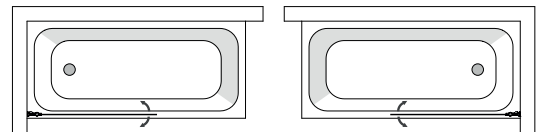

Душевая ширма **NEREA**

FR Notice de Montage - Utilisation - Entretien

ES Instrucciones de Montaje - Utilización - Mantenimiento

IT Istruzioni per il Montaggio - l'Uso - la Manutenzione

PT Instruções de Montagem - Utilização - Manutenção

EL Εγχειρίδιο συναρμολόγησης - χρήσης - συντήρησης

PL Instrukcja Montażu - Użytkowania - Konserwacji

RU Руководство По Сборке и Эксплуатации

KZ Жинау, пайдалану және техникалық қызмет көрсету нұсқаулығы

UA Керівництво По Збірці і Експлуатації

RO Manual asamblare - utilizare - întreținere

BR Instruções de Montagem, Utilização e Manutenção

EN Assembly - Use - Maintenance Manual

2020 - 04

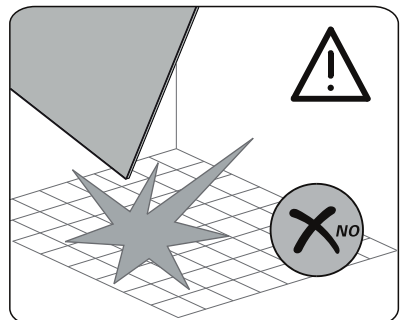
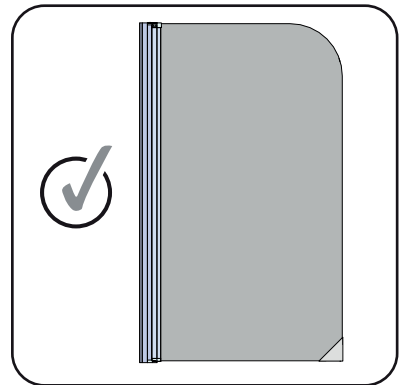
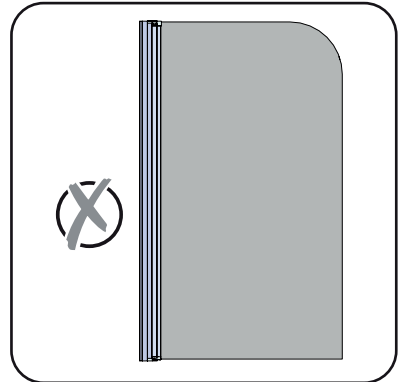
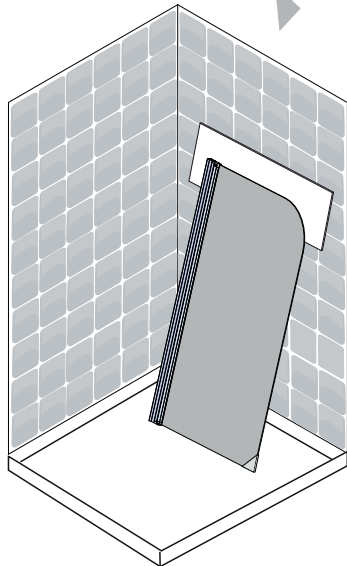
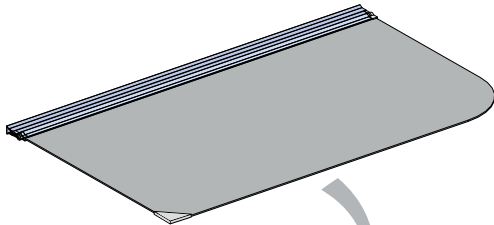
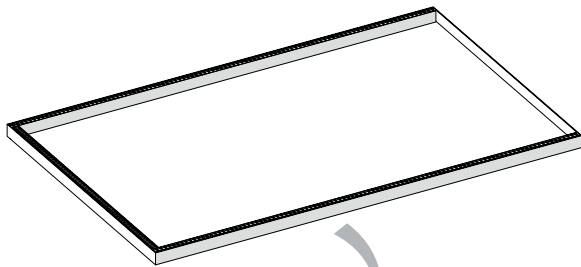
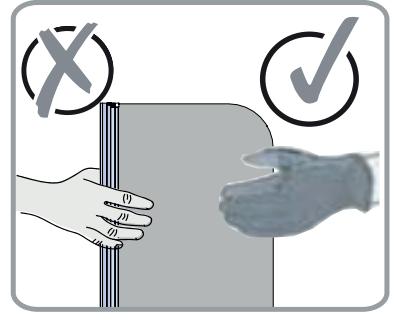
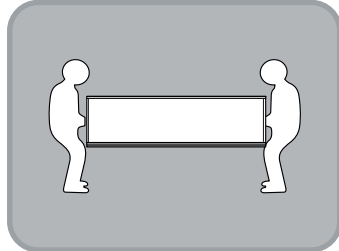
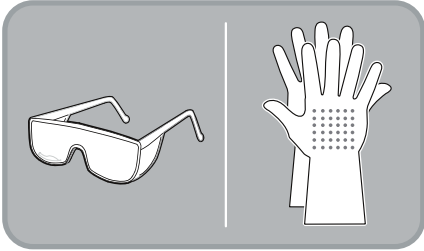
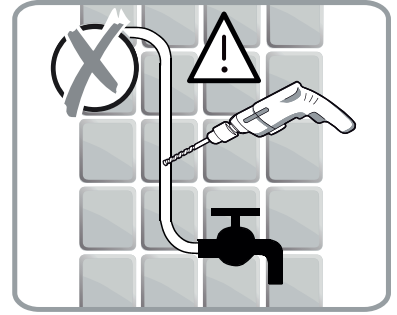
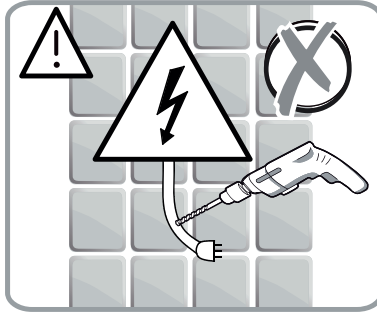
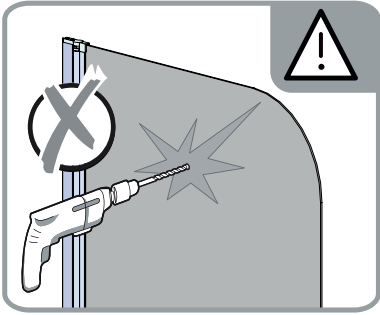

FR Vérifiez que les chevilles murales fournies sont appropriées à votre mur (celles fournies dans l'emballage sont conçues pour le béton). Sinon, utilisez des vis et des chevilles murales adaptées au type de matériau de votre mur. Pour obtenir des conseils concernant les vis et les chevilles appropriées à votre mur, demandez à un vendeur spécialisé.

ES Compruebe que todos los tacos suministrados puedan ser utilizados con su pared (los incluidos en la caja son para hormigón). En caso contrario, utilice tornillos y tacos de pared apropiados para el material de su pared. Para información acerca de las fijaciones y tornillos apropiados para su pared, consulte con un asistente de ventas especializado.

IT Verificare che i tasselli da parete forniti siano compatibili con la propria parete (quelli forniti con l'articolo sono per cemento). Altrimenti, utilizzare viti e tasselli adatti per la superficie della propria parete. Per ottenere consigli e suggerimenti sulle viti e i tasselli più adatti alla propria parete, consultare un rivenditore specializzato.

PT Certifique-se de que as buchas fornecidas são adequadas à sua parede (as fornecidas na embalagem são para betão). Caso contrário, use parafusos e buchas adequados ao tipo de material da sua parede. Para se aconselhar acerca dos parafusos e buchas adequados à sua parede, fale com um assistente de vendas especializado.

EL Βεβαιωθείτε ότι οι παρεχόμενες στερεώσεις τοίχου είναι κατάλληλες για τον τοίχο σας (οι παρεχόμενες στη συσκευή προορίζονται για μπετό). Αλλιώς χρησιμοποιήστε βίδες και στερεώσεις τοίχου κατάλληλες για τον τύπο υλικού του τοίχου σας. Για να λάβετε συμβουλές σχετικά με τις κατάλληλες βίδες και τα εξαρτήματα για τον τοίχο σας, ρωτήστε έναν ειδικό πωλητή.

PL Prosimy sprawdzić, czy dostarczone kołki do ścian nadają się do użycia w posiadanej ścianie (kołki dostarczone w zestawie są przeznaczone do betonu). Jeśli tak nie jest, należy użyć śrub i kołków odpowiednich do materiału, z którego wykonana jest ściana. Aby uzyskać poradę w sprawie śrub i elementów montażowych odpowiednich do danego typu ściany, należy zwrócić się z pytaniem do wyspecjalizowanego sprzedawcy.

RU Убедитесь, что прилагаемые дюбеля подходят для ваших стен (входящие в комплект дюбеля предназначены для бетона). В противном случае используйте шурупы и дюбеля, соответствующие материалу стены. Для получения рекомендаций по выбору шурупов и крепежных деталей, подходящих для вашей стены, обратитесь к специалисту-консультанту.

KZ Жеткізілетін қабырға анкерінің (қаланған тастарды ұстастыратын темір) сіздің қабырғаңызға үйлесімділігін тексеріңіз (жиынтыққа кіретіні бетонға арналған). Олай болмаған жағдайда, қабырғаңыздың материалының түріне сәйкес бұрмашеге мен қабырға анкерін пайдаланыңыз. Қабырғаңызға сәйкес бұрмашегелер мен бөлшектер туралы ақпарат алу үшін сату бөлімінің кеңесшісіне хабарласыңыз.

UA Перевірте, що анкери підходять для вашої стіни (ті, що постачаються в упаковці – для бетону). В іншому випадку використовуйте гвинти й стінові анкери, що відповідають матеріалу вашої стіни. Для отримання консультацій щодо гвинтів й фітінгів для вашої стіни зверніться до відповідного продавця-консультанта.

RO Verificați ca toate ancorele de perete furnizate să fie adecvate pentru peretele dumneavoastră (cele furnizate în pachet sunt pentru beton). În caz contrar, folosiți șuruburi și ancore de perete adecvate pentru tipul de material din care este peretele dumneavoastră. Pentru a obține recomandări privind șuruburile și armăturile adecvate pentru peretele dumneavoastră, întrebați un vânzător specializat.

BR Verifique se as buchas fornecidas são adequadas para sua parede (as fornecidas na embalagem são para concreto). Caso contrário, use parafusos e buchas adequados ao tipo de material da parede. Para obter conselhos sobre os parafusos e buchas adequadas à sua parede, questione um assistente de vendas especializado.

EN Check that wall anchors provided are suitable for your wall (those provided in the package are for concrete). Otherwise, use screws and wall anchors suited to the type of material of your wall. To obtain advice on the screws and fittings suited to your wall, ask a specialized sales assistant.



Attention danger / Atención: Peligro / Attenzione pericolo / Atencão perigo / Προσοχή κίνδυνος /
Uwaga niebezpieczeństwo / Внимание! Опасно! / Абайлаңыз / Увага! Небезпечно! /
Atenção, Pericol / Cuidado perigo / Caution danger /



Correct / Correcto / Corretto / Correcto / Σωστό / Dobrze / Правильный / Дұрыс /
Правильно / Corect / Correto / Correct /



Incorrect / Incorrecto / Errato / Incorrecto / Λάθος / Žle / Неправильный / Дұрыс емес /
Неправильно / Incorect / Incoreto / Incorrect /

Notes / Observaciones / Note / Notas / Σημειώσεις / Notatki / Примечания / Ескертпелер /

Примітки / Note / Observações / Notes

FR Préparation

ES Preparación

IT Preparazione

PT Preparação

EL Προετοιμασία

PL Przygotowanie

RU Подготовка

KZ Дайындау

UA Підготування

RO Pregătire

BR Preparação

EN Preparation

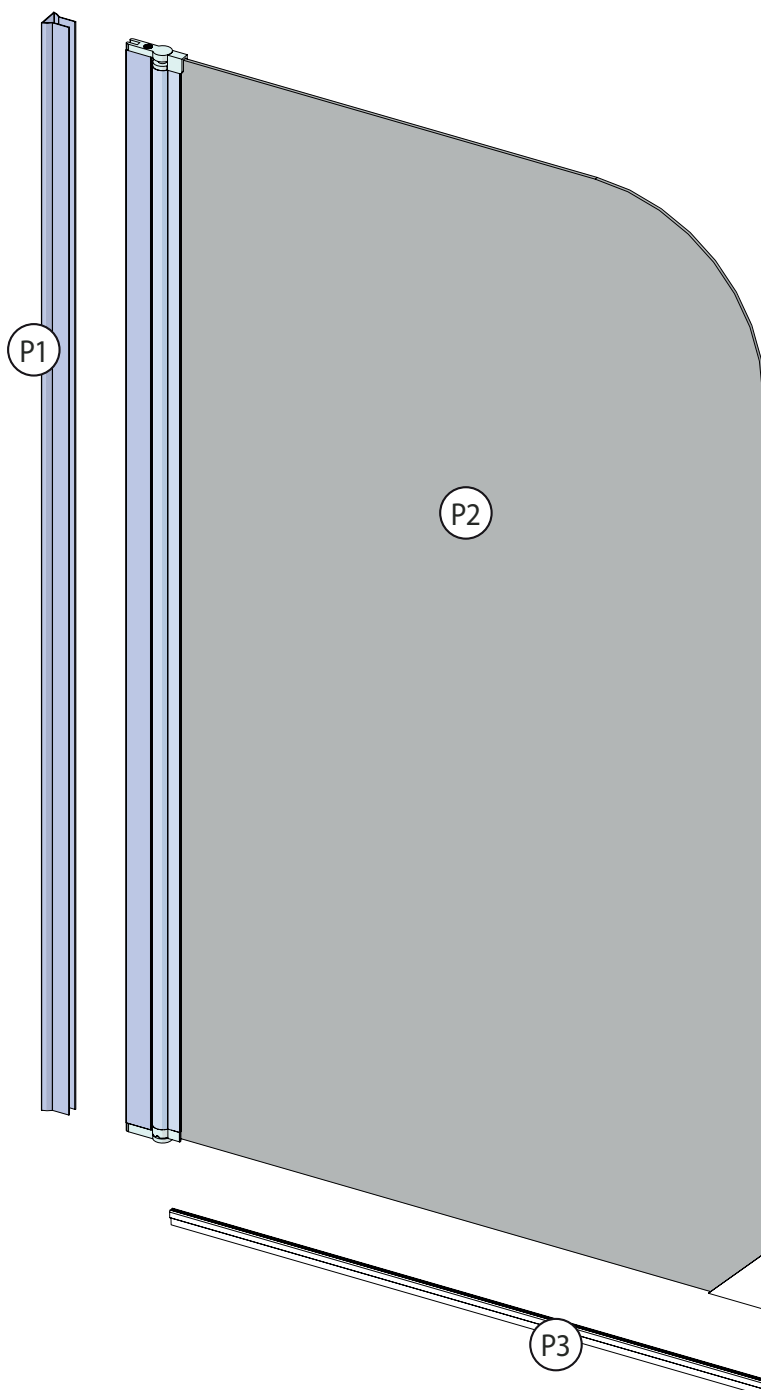
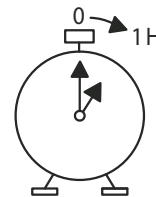
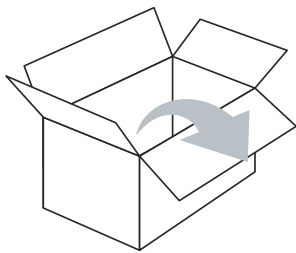

FR Préparation

ES Preparación

IT Preparazione

PT Preparação

EL Προετοιμασία

PL Przygotowanie

RU Подготовка

KZ Дайындау

UA Підготування

RO Pregătire

BR Preparação

EN Preparation

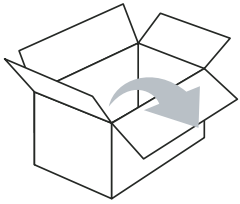

H1 x3

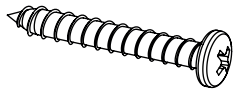

4x30mm

H4 x3

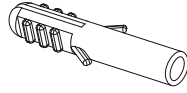

6x29mm

H14 x3

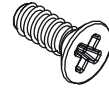

4x9.5mm

H5 x3



10x5mm

H6 x3



12x7mm

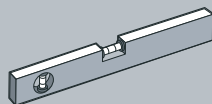
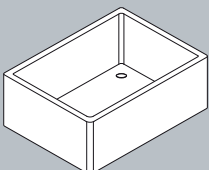
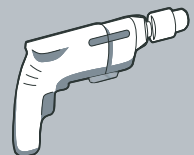
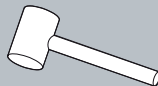
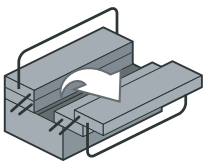

Ø6mm

Ø3mm

Not Included
brak w zestawie

non inclus
no incluido

δεν συμπεριλαμβάνονται
не входит до комплекты

Não incluído
neinclus

non incluso
Dahil değıildir

Не входит в комплект

FR Montage

ES Montaje

IT Montaggio

PT Montagem

EL Συναρμολόγηση

PL Montaż

RU Сборка

KZ Монтаждау

UA Збірка

RO Montaj

BR Montagem

EN Assembly

1

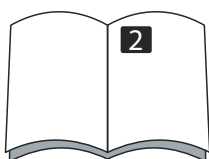
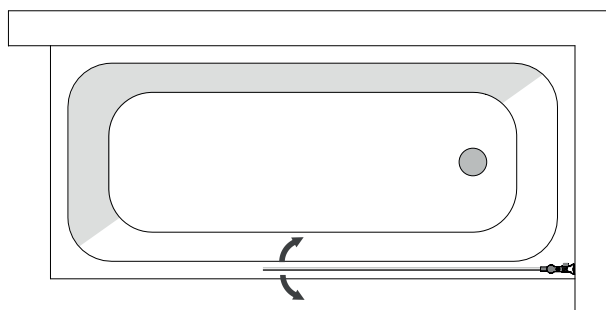
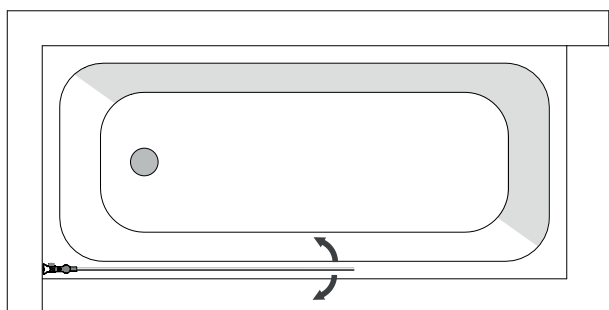
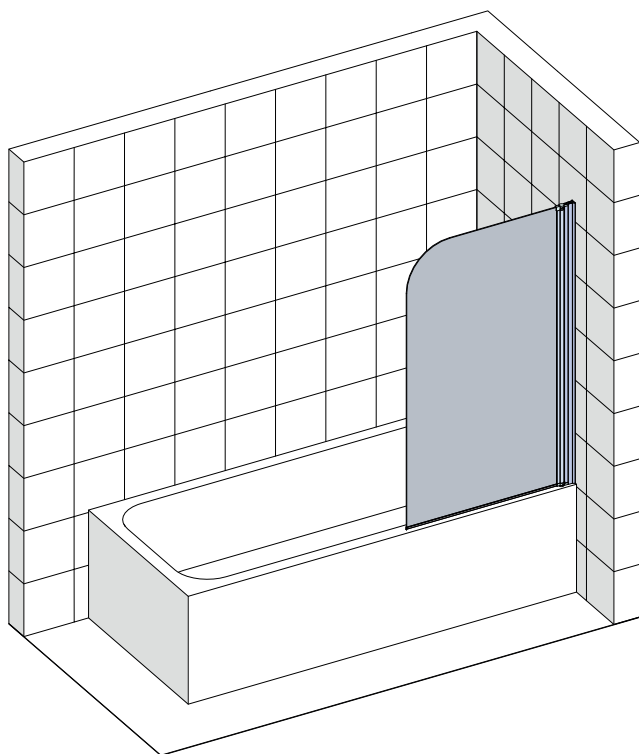
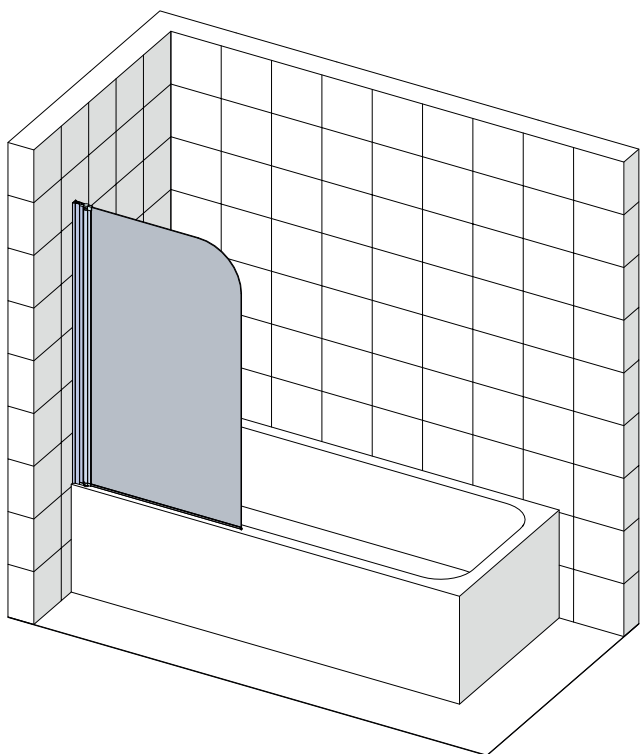

FR Montage

ES Montaje

IT Montaggio

PT Montagem

EL Συναρμολόγηση

PL Montaż

RU Сборка

KZ Монтаждау

UA Збірка

RO Montaj

BR Montagem

EN Assembly

2

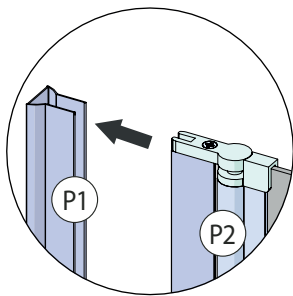
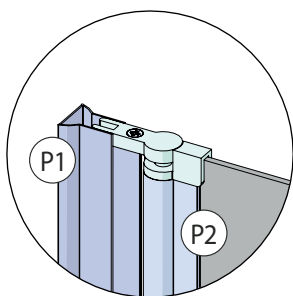
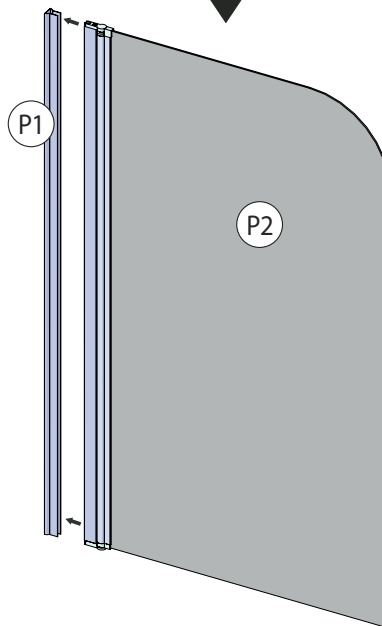
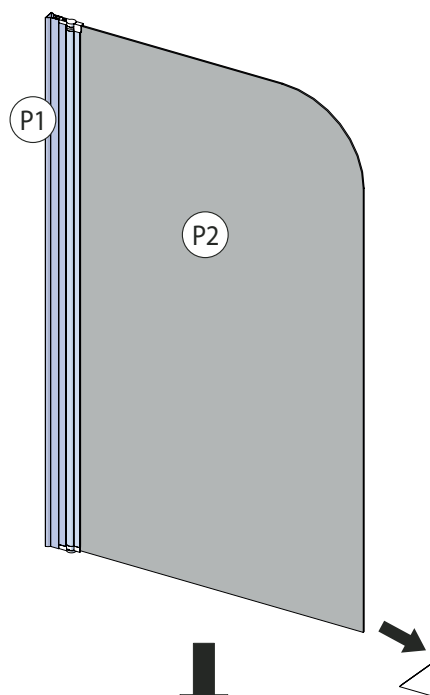
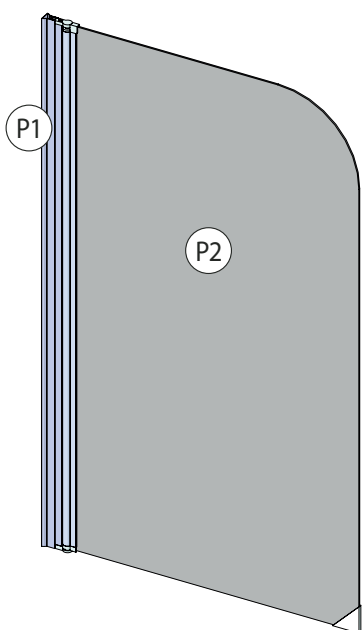
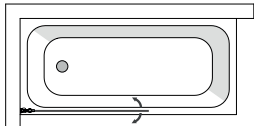
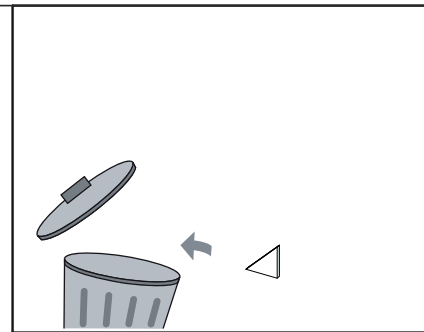
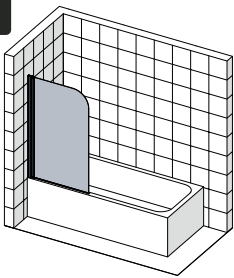

FR Montage

ES Montaje

IT Montaggio

PT Montagem

EL Συναρμολόγηση

PL Montaż

RU Сборка

KZ Монтаждау

UA Збірка

RO Montaj

BR Montagem

EN Assembly

3

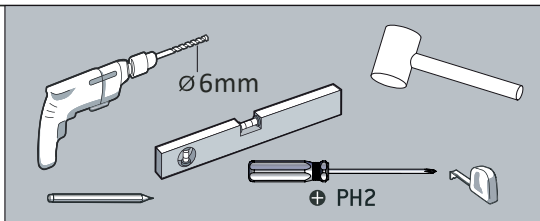
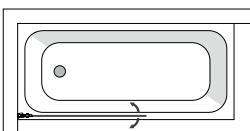
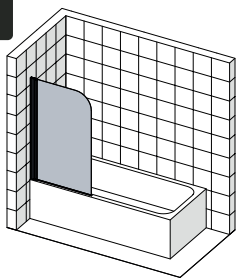

H1 x3

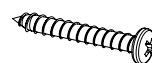

4x30mm

H4 x3



6x29mm

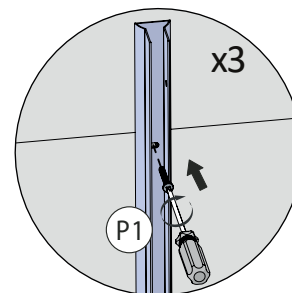
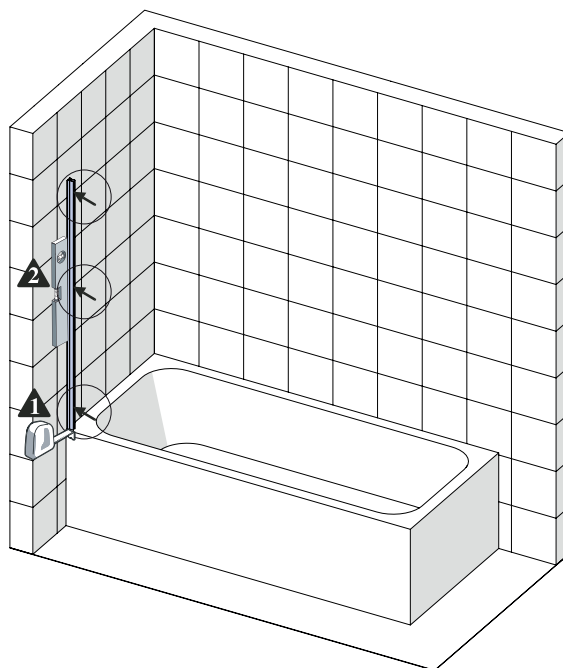
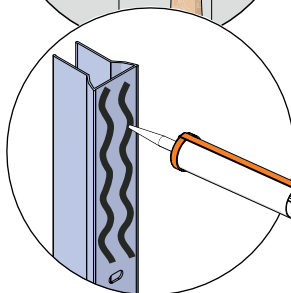
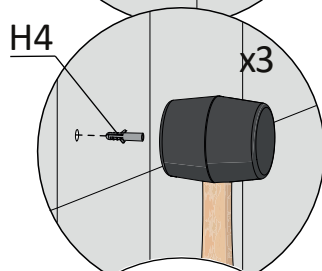
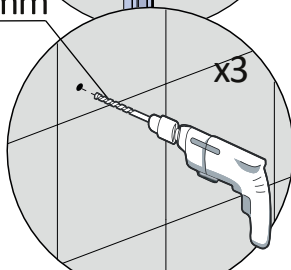
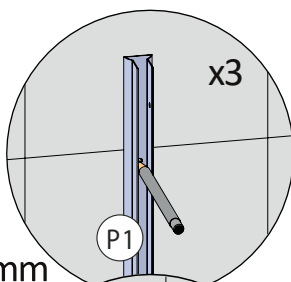
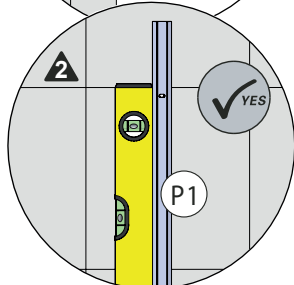
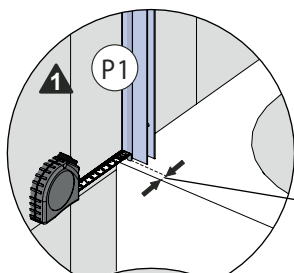
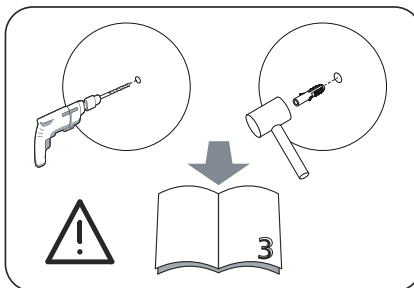

FR Montage

ES Montaje

IT Montaggio

PT Montagem

EL Συναρμολόγηση

PL Montaż

RU Сборка

KZ Монтаждау

UA Збірка

RO Montaj

BR Montagem

EN Assembly

4

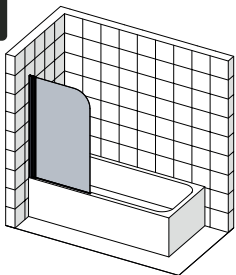

NEREA	X(mm)
760×1300mm	760-775

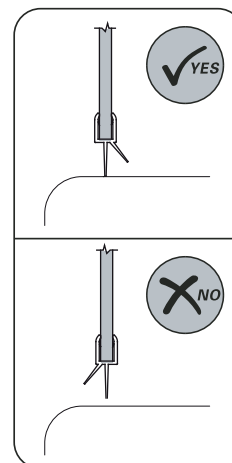
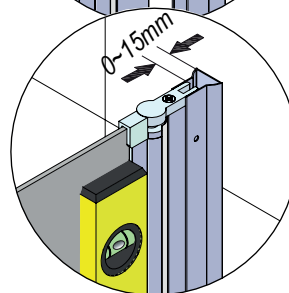
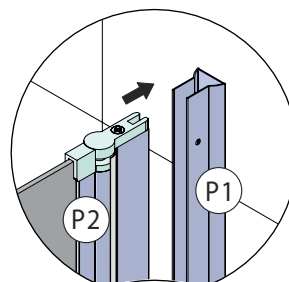
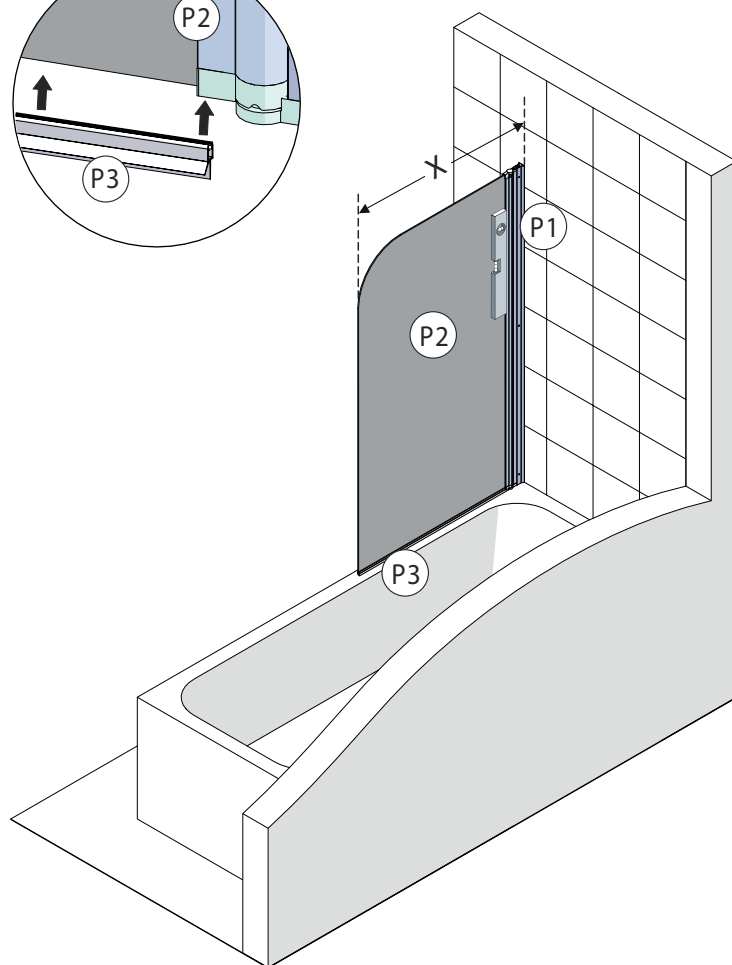
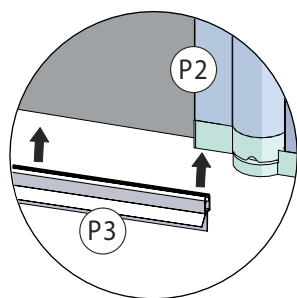
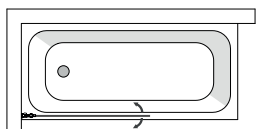
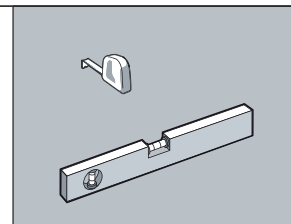

FR Montage

ES Montaje

IT Montaggio

PT Montagem

EL Συναρμολόγηση

PL Montaż

RU Сборка

KZ Монтаждау

UA Збірка

RO Montaj

BR Montagem

EN Assembly

5

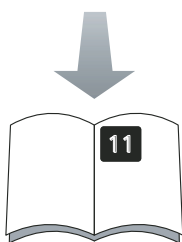
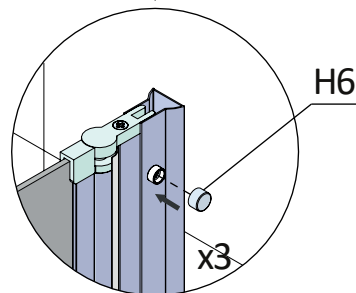
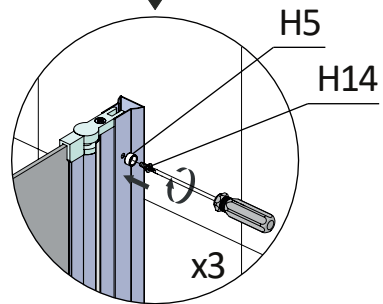
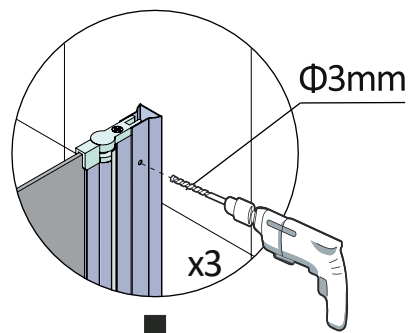
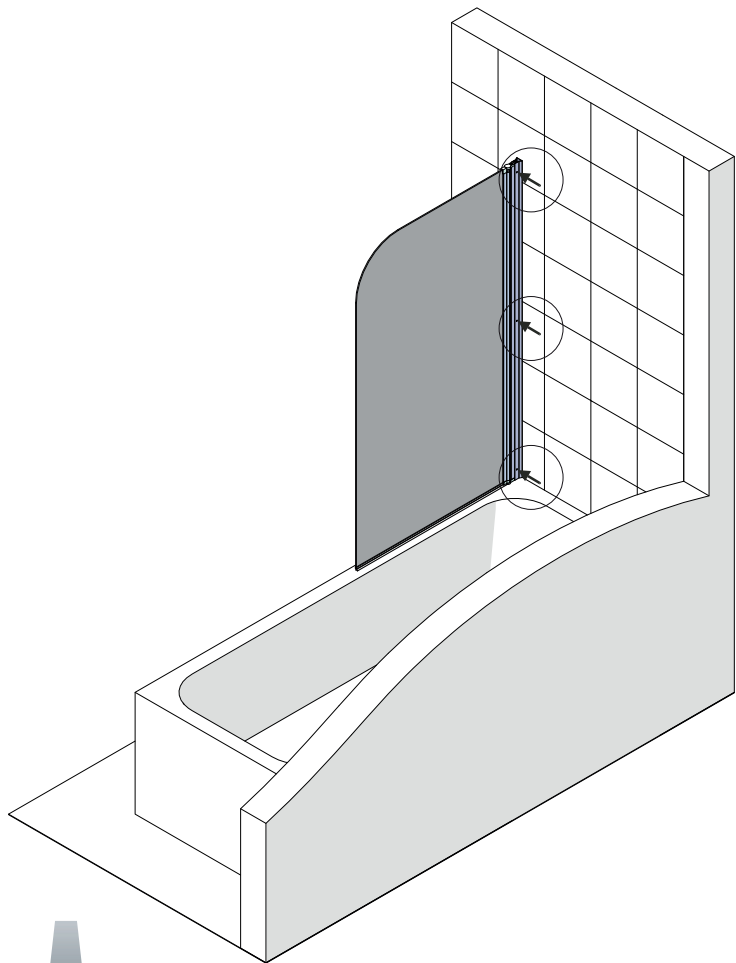
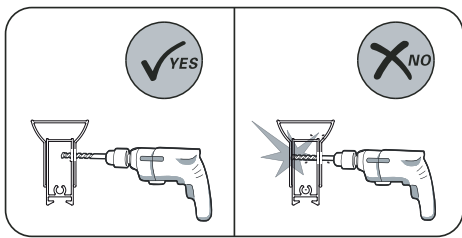
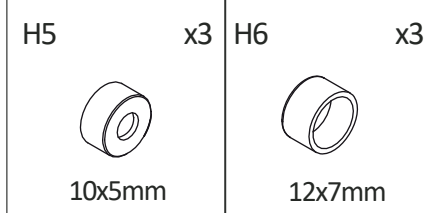
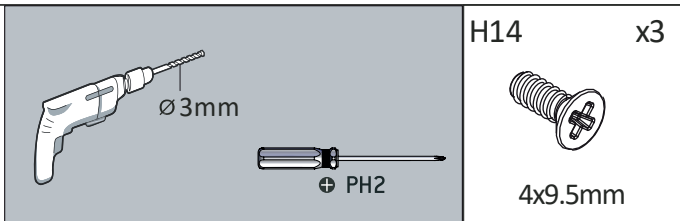
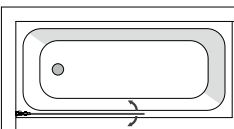
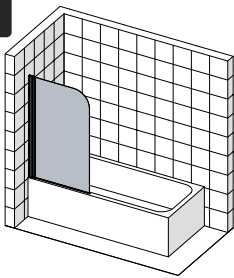

FR Montage

ES Montaje

IT Montaggio

PT Montagem

EL Συναρμολόγηση

PL Montaż

RU Сборка

KZ Монтаждау

UA Збірка

RO Montaj

BR Montagem

EN Assembly

6

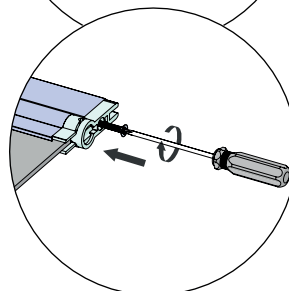
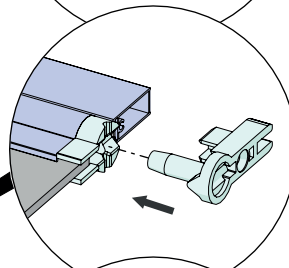
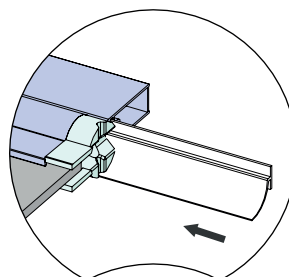
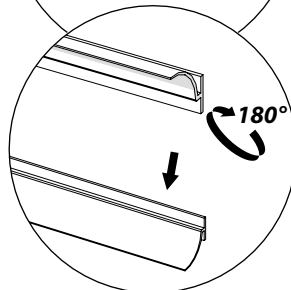
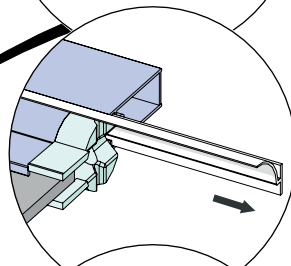
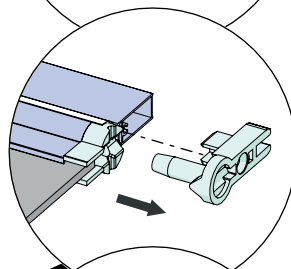
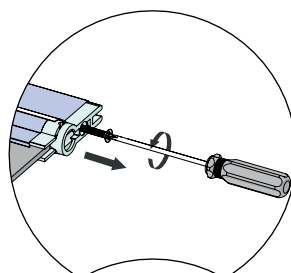
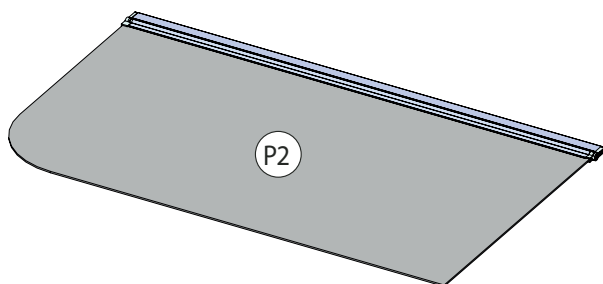
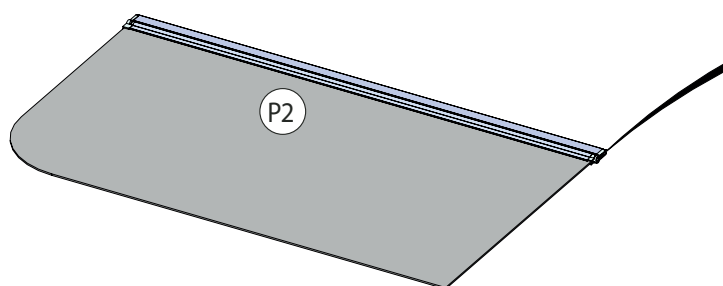
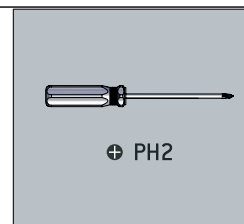
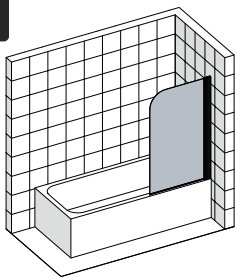

FR Montage

ES Montaje

IT Montaggio

PT Montagem

EL Συναρμολόγηση

PL Montaż

RU Сборка

KZ Монтаждау

UA Збірка

RO Montaj

BR Montagem

EN Assembly

7

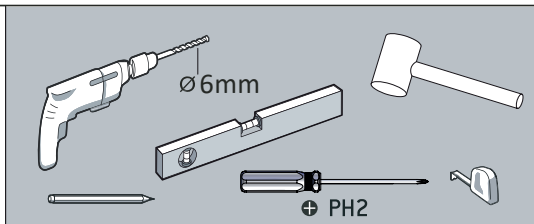
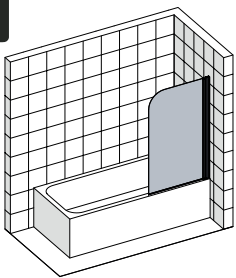

H1 x3

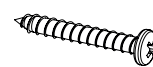

4x30mm

H4 x3



6x29mm

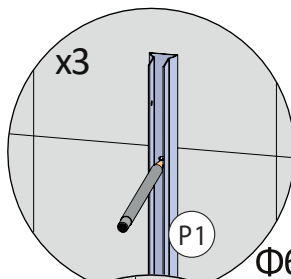
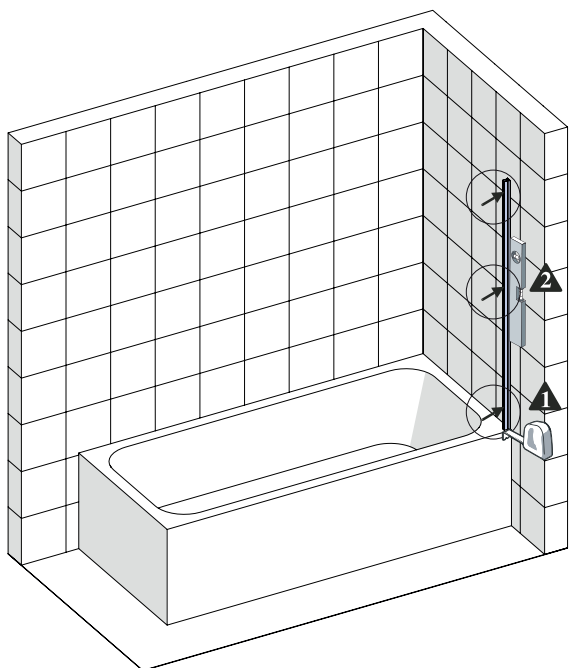
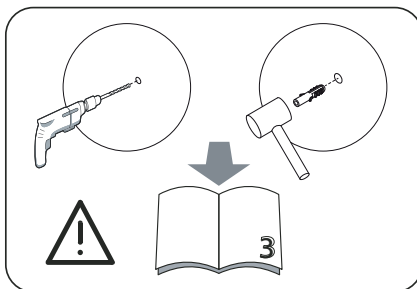

10mm

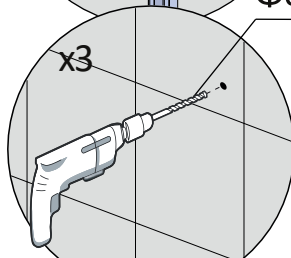
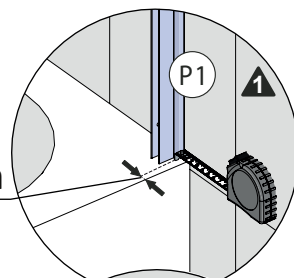

Ø6mm

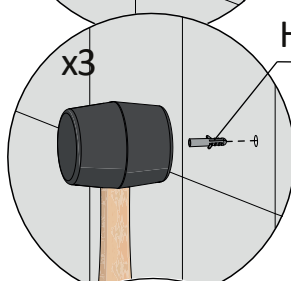
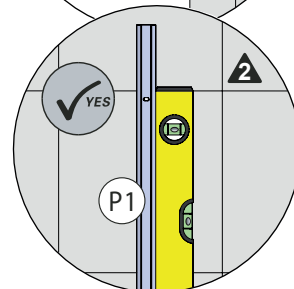

H4

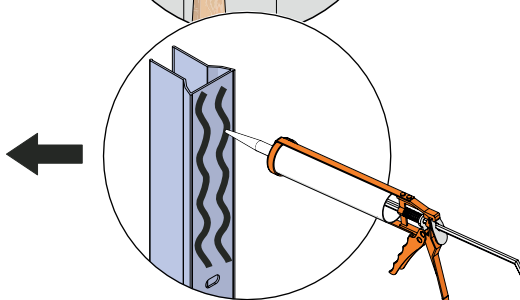
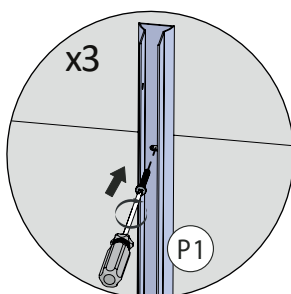

FR Montage

ES Montaje

IT Montaggio

PT Montagem

EL Συναρμολόγηση

PL Montaż

RU Сборка

KZ Монтаждау

UA Збірка

RO Montaj

BR Montagem

EN Assembly

8

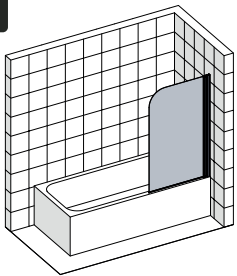

NEREA	X(mm)
760×1300mm	760-775

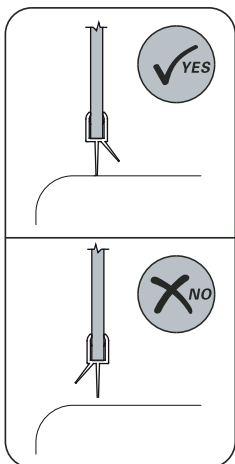
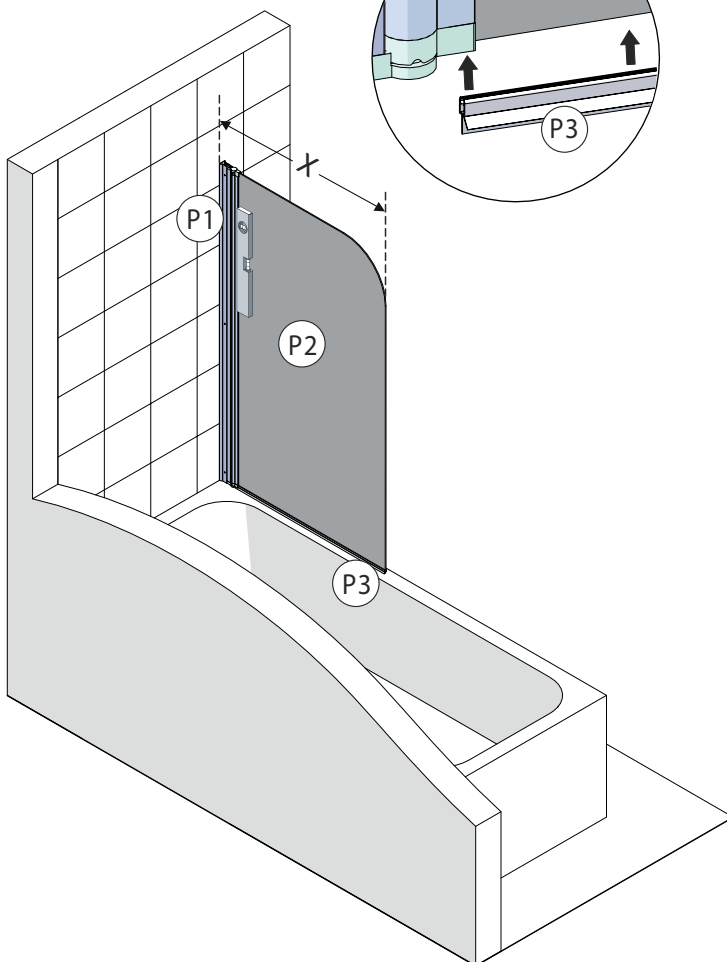
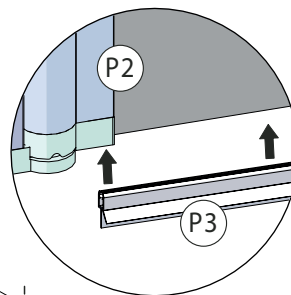
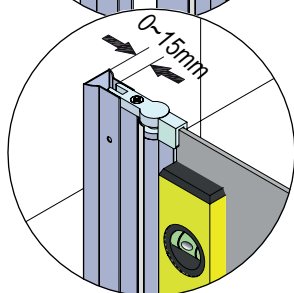
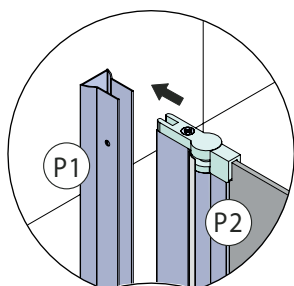
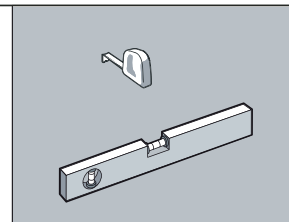

FR Montage

ES Montaje

IT Montaggio

PT Montagem

EL Συναρμολόγηση

PL Montaż

RU Сборка

KZ Монтаждау

UA Збірка

RO Montaj

BR Montagem

EN Assembly

9

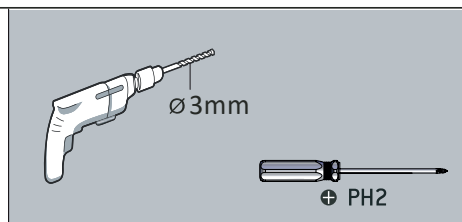
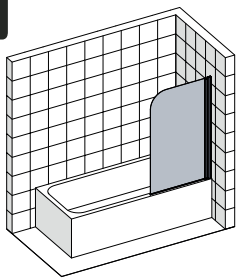

H14 x3

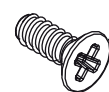

4x9.5mm

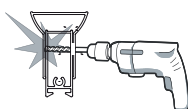
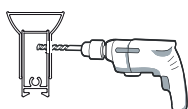

H5 x3



10x5mm

H6 x3



12x7mm

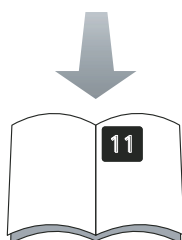
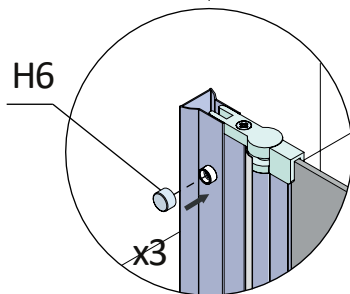
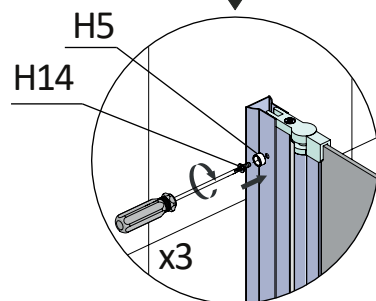
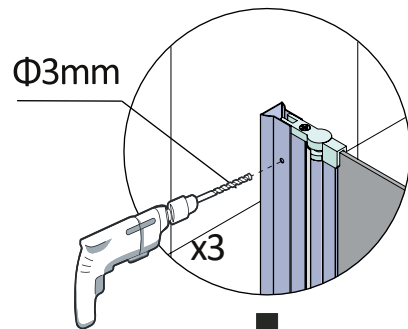
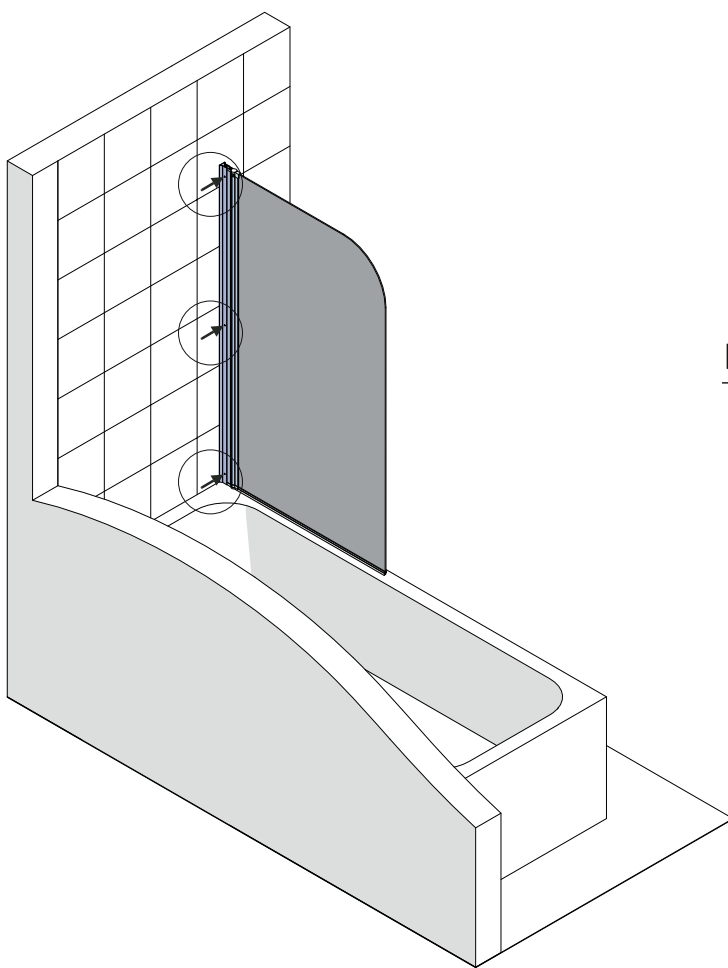
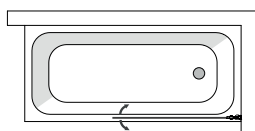

FR Montage

ES Montaje

IT Montaggio

PT Montagem

EL Συναρμολόγηση

PL Montaż

RU Сборка

KZ Монтаждау

UA Збірка

RO Montaj

BR Montagem

EN Assembly

10

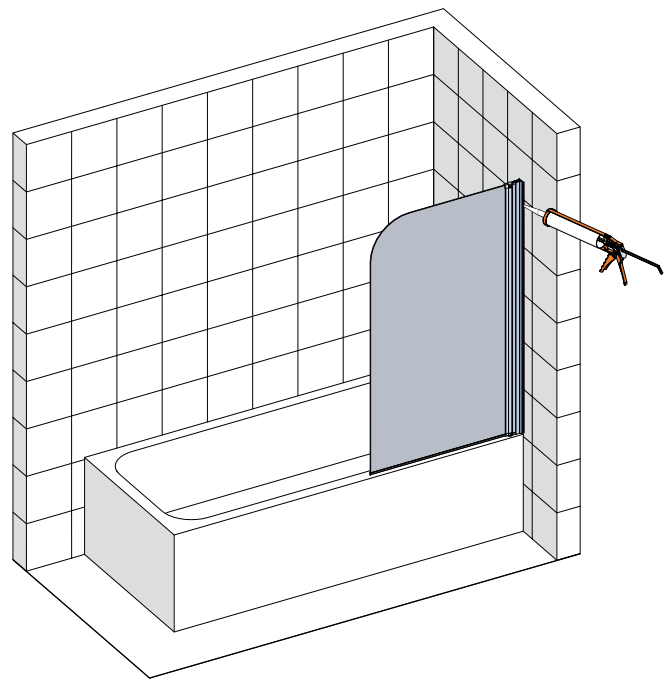
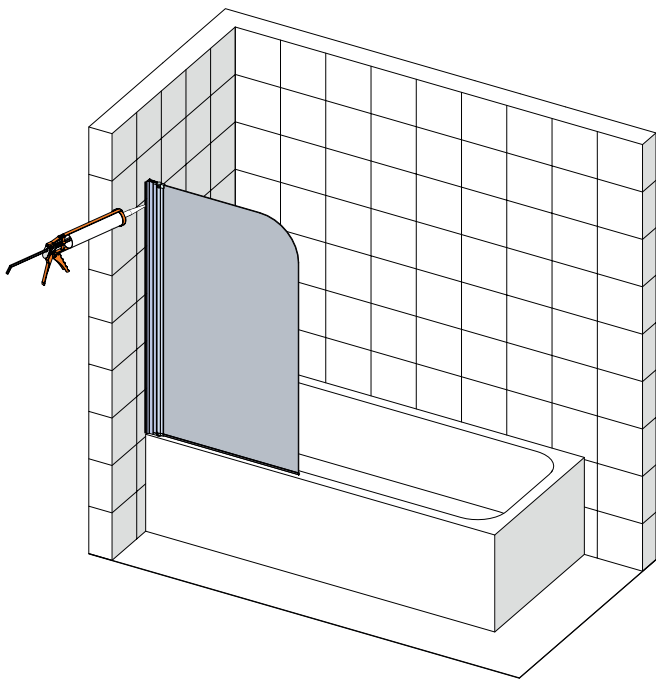
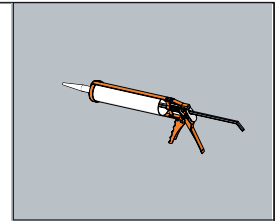
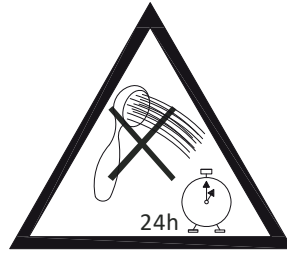

11



Sans solvant / Sin disolvente / Senza solventi / Sem solventes / Χωρίς διαλυτικά / Bez rozpuszczalnika / Без растворителя /
Без розчинника / Fără solvent / Solvent-free

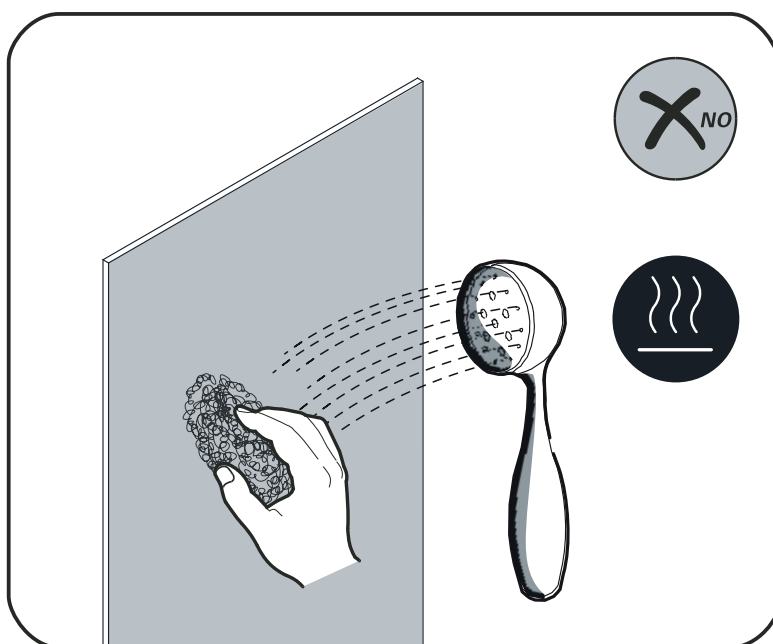
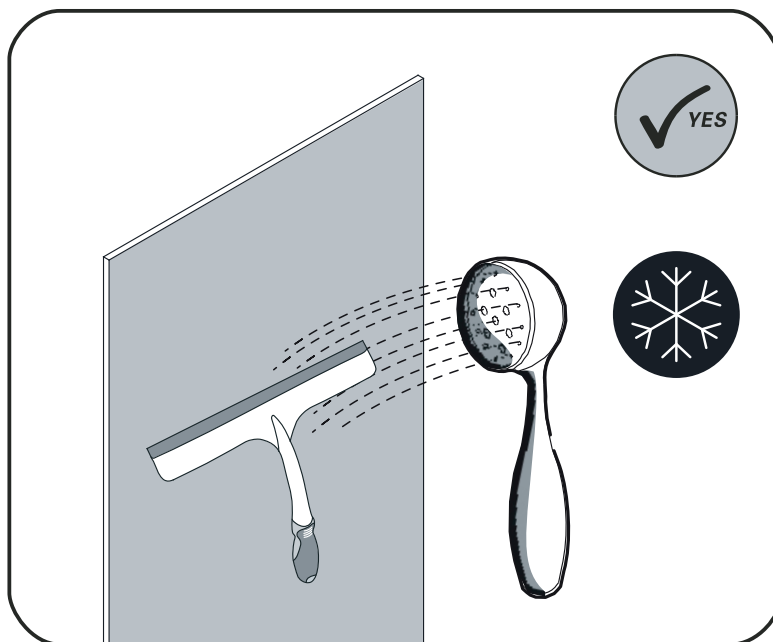

FR 

ADEO Services -135 Rue Sadi Carnot -
CS 00001 59790 RONCHIN - France
20
EN 14428: 2004+A1: 2008

Code d'identification unique
du produit type: **
usage prévu: hygiène personnelle
Nettoyable: Conforme
Résistance à l'impact/
Capacité de Fragmentation: Conforme
durabilité: Conforme

DOP N° 098116/0001/2020

ES 

ADEO Services -135 Rue Sadi Carnot -
CS 00001 59790 RONCHIN - France
20
EN 14428: 2004+A1: 2008

Código de identificación
única del producto tipo: **
Uso previsto: higiene personal
Limpiable: Conforme
Resistencia al impacto/
Capacidad de fragmentación: Conforme
Durabilidad: Conforme

DOP N° 098116/0001/2020

IT 

ADEO Services -135 Rue Sadi Carnot -
CS 00001 59790 RONCHIN - France
20
EN 14428: 2004+A1: 2008

Codice di identificazione
unico del prodotto-tipo: **
Uso previsto: igiene personale
Pulibile: Conforme
Resistenza agli urti/
Capacità di Frammentazione: Conforme
Durata: Conforme

DOP N° 098116/0001/2020

PT 

ADEO Services -135 Rue Sadi Carnot -
CS 00001 59790 RONCHIN - France
20
EN 14428: 2004+A1: 2008

Código de identificação
único do produto-tipo: **
Utilização prevista: higiene pessoal
Limpeza: Conforme
Resistência ao impacto/
Capacidade de fragmentação: Conforme
Durabilidade: Conforme

DOP N° 098116/0001/2020

EL 

ADEO Services -135 Rue Sadi Carnot -
CS 00001 59790 RONCHIN - France
20
EN 14428: 2004+A1: 2008

Μοναδικός κωδικός ταυτοποίησης
του τύπου του προϊόντος: **
προβλεπόμενη χρήση: προσωπική υγιεινή
Δυνατότητα καθαρισμού: Σύμφωνα με
Αντοχή σε κρούση/
Ικανότητα κατάτμησης: Σύμφωνα με
Διάρκεια: Σύμφωνα με

DOP N° 098116/0001/2020

PL 

ADEO Services -135 Rue Sadi Carnot -
CS 00001 59790 RONCHIN - France
20
EN 14428: 2004+A1: 2008

Niepowtarzalny kod
identyfikacyjny typu wyrobu: **
przeznaczenie: higiena osobista
Możliwość czyszczenia: Zgodny
Odporność na uderzenia/
Rozkruszalność: Zgodny
Trwałość: Zgodny

DOP N° 098116/0001/2020

RO 

ADEO Services -135 Rue Sadi Carnot -
CS 00001 59790 RONCHIN - France
20
EN 14428: 2004+A1: 2008

Cod unic de identificare
a tipului de produs: **
destinație: igienă personală
Posibilitatea de curățare: Conform
Rezistență la impact/
Capacitate de fragmentare: Conform
Durabilitate: Conform

DOP N° 098116/0001/2020

EN 

ADEO Services -135 Rue Sadi Carnot -
CS 00001 59790 RONCHIN - France
20
EN 14428: 2004+A1: 2008

Unique identification code
of the product-type: **
Intended use: personal hygiene
cleanability: Pass
Impact resistance/ shatter properties: Pass
Durability: Pass

DOP N° 098116/0001/2020

**

FR Reportez-vous à l'annexe.

ES Consulte el apéndice.

IT Consultare l'appendice.

PT Consulte o anexo.

EL Ανατρέξτε στο Παράρτημα.

PL Patrz załącznik.

RO Consultați anexa.

EN Refer to appendix.

FR/ Annexe

ES/ Apéndice

IT/ Appendice

PT/ Anexo

EL/ Παράρτημα

PL/ Załącznik

RU/ Приложение

KZ/ Қосымша

UA/ Додаток

RO/ Anexa

BR/ Apêndice

EN/ Appendix

EAN CODE	**MODEL NO.	SIZE(mm)	PROFILE
3276007112276	NER-4BS130-C-C	1300×760	Silver
3276007112283	NER-4BS130-W-P	1300×760	White

ADEO Services - 135 Rue Sadi Carnot - CS 00001
59790 RONCHIN - France

ТОВ «Леруа Мерлен Україна»,
вул. Полярна 17а, м. Київ 04201, Україна

Importado e distribuído por LEROY MERLIN CIA BRASILEIRA DE BRICOLAGEM - CNPJ 01.438.784/0001-05
Rua Domingas Galleteri Blotta, nº315 - Jd Consórcio - São Paulo/SP - CEP 04455-360
CALM (Central de Atendimento Leroy Merlin): Capitais 4020-5376 - Demais Regiões 0800-0205376
IMAGENS ILUSTRATIVAS*

Imported by Adeo South Africa (PTY) LTD T/A Leroy Merlin,
Hosted in Leroy Merlin Fourways Store 35 Roos Street, Witkoppen Ext 97, Sandton, 2191 Johannesburg,
Gauteng, South Africa
Tel: +27 10 493 8000 Email: contact@leroymerlin.co.za

Импортер\Продавец\Организация, уполномоченная принимать претензии по качеству товара в
РФ: ООО «ЛЕРУА МЕРЛЕН ВОСТОК», 141031, Россия, Московская Обл., г. Мытищи, Осташковское шоссе, д.1

Импортер\Продавец\Организация, принимающая претензии по качеству продукции в
Республике Беларусь: ООО «Леруа Мерлен Бел», 220020, Республика Беларусь, г. Минск, пр-т Победителей, д. 100, офис. 503

Импорттаушы\Сатушы \Қазақстан Республикасында өнім сапасы бойынша наразылықтарды қабылдайтын ұйым:
«Леруа Мерлен Қазақстан» ЖШС, Қазақстан Республикасы, 050000, Алматы қ., Қонаев көшесі, 77, «PARK VIEW» БО, 6-қабат, 07-кеңсе
Импортер\Продавец\Организация, принимающая претензии по качеству продукции в Республике Казахстан:
ТОО «Леруа Мерлен Казахстан», Республика Казахстан, 050000, г. Алматы, ул. Кунаева, 77, БЦ «PARK VIEW», 6 этаж, офис № 07



Made in P.R.C.2020
Сделано в Китае